

Pentalateral Energy Forum Support Group 2

Generation Adequacy Assessment April 2020

FINAL REPORT



Information about this document:

Description	Pentalateral generation adequacy assessment	
Version	Final	
Date	May 2020	
Status	<input type="checkbox"/> Draft	<input checked="" type="checkbox"/> Final version

Disclaimer:

It must be noted that the results and conclusions in this report are inseparable to the hypotheses described and can only be read in this reference framework. The hypotheses were gathered by the TSOs according to their best knowledge at the moment of the data collection (end 2019), validated by ministries, and consulted with regulators within the Pentalateral Forum. The TSOs emphasise that the TSOs involved in this study are not responsible in case the hypotheses taken in this report or the estimations based on these hypotheses are not realised in the future.

Executive summary

This report provides the main findings of the third edition of the Pentalateral Generation Adequacy Assessment (PLEF GAA 3.0). The study was carried out by the Transmission System Operators of the seven countries cooperating in the Pentalateral Energy Forum (PLEF): Austria, Belgium, France, Germany, Luxembourg, the Netherlands and Switzerland (PLEF countries/region).

The Pentalateral Energy Forum is the framework for regional cooperation in Central Western Europe (AT-BE-DE-FR-LU-NL-CH) towards improved electricity market integration and security of supply.

This third edition of the PLEF Generation Adequacy Assessment, mandated by the Political Declaration of the Pentalateral Energy Forum of 7 June 2013 in which the Ministers of Energy requested a Pentalateral Generation Adequacy Assessment, establishes some key features developed in the previous editions and elaborates them further. It continues to provide a probabilistic analysis on electricity security of supply in Europe focussing on a regional perspective, thus making it possible to better assess generation adequacy jointly, on a regional scale covering the PLEF countries.

The know-how on methodology as developed by the PLEF TSOs during the first and second PLEF GAA was transferred and applied within the association of European Electricity TSOs (ENTSO-E) in the Midterm Adequacy Forecast (MAF). Nowadays significant methodological evolutions also occur within the Midterm Adequacy Forecast (MAF) group of ENTSO-E and therefore the PLEF GAA also profits back from the ENTSO-E work. Furthermore the PLEF TSO still rely significantly on methodological evolutions by national TSO within national studies.









The definition of the sensitivities was performed in collaboration between Ministries, Regulators and TSOs in the PLEF group and has turned out to be a major added value for this 3rd Regional adequacy assessment. These sensitivities provide so-called 'stress test' situations for the region, to e.g. test its resilience.

Compared to the second assessment, the following important areas of improvement have been considered in the third assessment:

- The usage of a flow-based (FB) model as the standard methodology. In the second edition, the flow-based methodology was implemented for the short term horizon (2018/2019) only since the modelling approach relied on historic flow-based data. For the third assessment, the time horizon 2025 was considered and the flow-based approach needed to be enhanced. Flow-Based modelling for the midterm horizon considering all implemented grid investments for the considered time horizon (2025) and including the 70% minRAM requirements from CEP was a complex and time consuming task, for which PLEF TSO profited from methodological evolutions within national studies by TSOs. Furthermore, the Flow-Based approach applied in this study provides a benchmark for the expected methodological evolution within the European Resource Adequacy Assessments (ERAA) as required by the Clean Energy Package (CEP). The flow-based (FB) model used in this study is described in details in Chapter 3.8.2 of this document.
- A dedicated analysis on critical hours has been performed including a comparison with historical situations.
- Regarding the climate database, an important improvement is the inclusion of hydrological data by ENTSO-E within its Pan-European Climate Database (PECD). While in the second edition only three degrees of water availability were combined with climatic input data for re-

newables, this third edition considers the evolved ENTSO-E PECD, which assigns different historic inflow values to each climate year. This is a major data-related improvement from the perspective of hydro-dominated countries such as Austria and Switzerland. Furthermore, the climate database has been extended by two more years. For the third edition, the PECD data used comprises the climate years 1982 to 2016 (i.e. 35 years in total).

The results for the PLEF base case 2025 show that LOLE values do not (significantly) exceed the reliability standards set by some of the PLEF countries. Both in the base case and the sensitivities analysed, for all countries of the PLEF Region, except for the Netherlands, LOLE is above zero. The two sensitivity analyses show that adequacy risks can occur, since LOLE values significantly exceed the reliability standards set by some of the PLEF countries.

		PLEF 2025 Base Case		PLEF 2025 Low Gas (-7,5GW)		PLEF 2025 Low Nuclear (-2,9GW)/ Low NTC CH	
Area	ENS [MWh]	LOLE [h]	ENS [MWh]	LOLE [h]	ENS [MWh]	LOLE [h]	
 AT	819	1,7	2004	3,8	1055	2,3	
 BE	3706	3,3	15290	8,1	5328	4,6	
 CH	98	0,2	1178	1,4	4001	2,9	
 DE ¹	2440	0,6	6526	1,6	2927	0,7	
 FR	9766	3,3	22543	7,1	15847	4,6	
 LU ¹	31	0,6	83	1,6	37	0,7	
 NL	0	0,0	0	0,0	0	0	

In this study, the assumptions for capacity in some countries consider capacity relying in market wide capacity mechanisms.

For Germany the Capacity Reserve was considered in an ex-post analysis, as the German reserve is not participating in the energy market. Together with the Capacity Reserve also 1 GW of switchable loads, which are also not participating in the energy market, were considered. At the point in time of this study, roughly 1GW of capacity reserve was contracted by the German TSO until 2022 since there were not enough offers to cover the full 2 GW reserve capacity demand. It is however envisaged that 2GW of capacity reserve will be contracted by 2025.

As stated above, one of the main improvements of this study is the usage of a FB approach at the regional level for the mid-term horizon of 2025 for the CWE region. Contrary to the constant NTC values defined for long-term planning, representative FB domains are chosen as basis and linked to the expected climate and consumption conditions for every hour of the assessed target year

As explained in Chapter 3.8.2, the FB parameters are calculated by use of grid models covering the flow-based area under consideration and suited for the target time of the assessment. European grid models from the TYNDP reference grid are used incorporating the relevant grid modifications expected to be operational by the target time of the assessment.

¹ The German capacity reserve has not been modelled in the market, but was integrated in an out-of-market analysis of the results for Germany and Luxembourg. For further information, please see chapter 6.5. Results presented for Luxembourg are referencing to the market node LUG. Further information is provided under chapter 3.8.3 'Import/Export capacity for areas outside the FBMC area: NTC approach'

Furthermore, in line with the Clean Energy Package regulation, a minimum of 70% of the thermal capacity between adjacent zones is assumed to be made available for cross-border trade (CWE 70% minRAM) in 2025.

The study also considers the effect of curtailment minimization and curtailment sharing following the principles of the EUPHEMIA market coupling algorithm, within the results of the generation adequacy simulations.

The study only investigates adequacy of wholesale markets. A perfect market modelling assumption is made in which the wholesale market is modelled as if all energy was sold on a daily basis. It is important to keep this assumption in mind in relation to the adequacy patch mentioned above.

Furthermore, redispatch also lies outside the scope of this report. This implies that the results of this study are only valid if internal congestions do not reduce the assumed availability of capacity offered for cross-border trade in 2025 in the context of CWE 70% minRAM.

Finally, perfect foresight is considered, hence real-time balancing adjustments made by TSO by use of operational reserves are assumed to ensure frequency stability and operational grid security. Some reflections on this assumption are given further within the critical hours analysis.

The analysis of critical hours shows that despite their low probability of occurrence, critical situations are observed both in the PLEF simulations as well as in real system operation over the last years. In turn this means, even with low LOLE and EENS levels in adequacy simulations, the electrical system might face particular situations where system security is under stress. Additional unforeseen events in such situations can put the daily system operation even more under pressure, which might in turn lead to the activation of exceptional measures. The risks in such particularly critical situations are not reflected in the statistical adequacy indicators of the PLEF simulation results (LOLE and EENS).

Outlook beyond 2025

This study considers the year 2025 as main time horizon. Hence, there is still a significant amount of coal and lignite capacity in the PLEF area by 2025 (more than 25 GW) in this study. Additional coal capacity might be decommissioned from 2025 onwards, when countries will be preparing to reach the 2030 EC Green Deal targets. This is not addressed in this PLEF study, but might have to be considered in future adequacy studies. This year is within the target of the new ERAA.

Contents

1.	Introduction.....	5
2.	General approach.....	9
3.	Methodology.....	10
3.1	Preparation of input data.....	10
3.2	Pan-European Climate Database.....	10
3.2.1	Load.....	10
3.2.2	Wind and Solar.....	11
3.2.3	Hydro.....	11
3.2.4	Thermal units and outages.....	12
3.3	Outages of HVDC lines.....	13
3.4	Fuel and CO2-prices.....	13
3.5	Perimeter.....	13
3.6	Balancing Reserves.....	14
3.7	System Adequacy Mechanisms.....	15
3.8	Grid modelling.....	19
3.8.1	NTC vs. FB Model.....	19
3.8.2	CWE Flow-Based Model.....	20
3.8.3	Import/Export capacity for areas outside the FBMC area: NTC approach.....	25
3.9	Generation Adequacy Models.....	26
3.9.1	Advanced tools.....	27
3.9.2	Adequacy indicators and relevant model outputs.....	28
3.9.3	Monte Carlo scheme - Convergence.....	29
3.9.4	Benefits from using two simulators.....	31
3.9.5	Curtailment sharing.....	31
3.9.6	Sensitivity of the results to the whole set of Monte Carlo years.....	32
4.	Input data, assumptions and country specifics.....	36
4.1	Austria.....	36
4.2	Belgium.....	37
4.3	France.....	39
4.4	Germany.....	41
4.5	Luxembourg.....	43
4.6	Switzerland.....	44
4.7	The Netherlands.....	46

5.	Study framework.....	48
5.1	Base case	48
5.2	Sensitivities.....	49
6.	Results of the adequacy assessment.....	51
6.1	Synopsis of results in MAF 2019, target year 2021, and PLEF 3.0, target year 2025	51
6.2	Results summary PLEF GAA 3.0 for 2025	52
6.3	Sensitivity of Base Case results on Monte Carlo years.....	54
6.4	Focus on representative critical hours	55
6.4.1	Past constraining situations from system operations perspective	55
6.4.2	Simulations made in the PLEF study for 2025	56
6.4.3	Conclusions on critical hours analyses	57
6.5	Impact of capacity reserves in Germany on the LOLE results for 2025	58
6.6	Disclaimers and TSO Comments on results.....	58
6.6.1	Austria	58
6.6.2	Belgium.....	59
6.6.3	Germany.....	60
6.6.4	France	60
6.6.5	Luxembourg.....	61
6.6.6	Switzerland	62
7	Conclusions and Lessons learnt.....	63
8	Appendix.....	65
8.1	FB modelling details	65
8.2	Adequacy Patch details	67
8.3	Glossary	70
8.4	Contacts.....	71

Index of figures and tables

Figure 1 Process of study performance.....	9
Figure 2 Perimeter of the modelled countries in this study	14
Figure 3 System adequacy mechanisms (in place or under development) in Central Western Europe	16
Figure 4: [Figure taken from ‘Bilan prévisionnel de l’équilibre offre-demande d’électricité en France’] Net annual revenue for gas plants from 2015 to 2019	18
Figure 5 NTC vs FB	20
Figure 6 [Figure from ‘Adequacy and flexibility study for Belgium 2020 – 2030’] Overview of the different steps in the process of the determination of the flow-based domains.....	21
Figure 7: [Figure from ‘Adequacy and flexibility study for Belgium 2020 – 2030’] Belgium France domain.....	24
Figure 8 Methodology of combining various possible outcomes to achieve statistically representable results	27
Figure 9: Rationale behind the construction of simulated years, based on an example with 35 climate years and 29 outage scenarios.....	30
Figure 10: Convergence of the adequacy indicators Loss of Load Expectation (LOLE).....	30
Figure 11 Process of using two simulations in parallel	31
Figure 12: Distribution of Future States	32
Figure 13: Consideration of cold spell in 1985 and 1987	33
Figure 14: 1985 temperatures in France between December 1st 1984 and February 28th 1985.....	34
Figure 15 Generation mix (operational capacities) of Austria base case 2021 and 2025.....	36
Figure 16 Generation mix (operational capacities) of Belgium base case 18/19 and 23/24	38
Figure 17 Generation mix (operational capacities) of France base case 18/19 and 23/24	39
Figure 18 Margins in the base case and in other scenarios of ten-yearly inspections	41
Figure 19 Generation mix (operational capacities) of Germany base case 2021 and 2025	43
Figure 20 Generation mix (operational capacities) of Luxembourg base case 2021 and 2025	44
Figure 21 Generation mix (operational capacities) of Switzerland fore 2021 and 2025	45
Figure 22 Generation mix (operational capacities) of The Netherlands base case 18/19 and 23/24 ..	47
Figure 23: MAF 2019 results for the time horizon 2021. Left: NTC approach. Right: Flow-based approach.....	51
Figure 24: Average LOLE for the base case and the two sensitivities in the geographical context	52
Figure 25 Distribution of # hours with ENS per future state (Monte Carlo years). LOLE refers to average number of hours with ENS.....	54
Figure 26: Qualitative distribution of situations with average and extreme conditions.	55
Figure 27: Historic load and RES values for the PLEF region for the time period (09.01.17 - 30.01.17).	56
Figure 28: Simulation results for one week with RES infeed and consumption summed up for all PLEF countries. Occurrence of ENS is also indicated.	57
Figure 29: Systematic example for the difference between market flow and the real physical flows taken into consideration when using FB modelling	65
Figure 30: Example of flow-based domain (see CWE Flow-Based).....	67
Figure 31 Adequacy Patch principles	69

Table 1 Features of regional and national analyses	7
Table 2 Existing Adequacy Standards in PLEF.....	8
Table 3: EU fuel and CO2 prices of PRIMES.....	13
Table 4 Balancing reserves for 2025 horizon	15
Table 5: [Table from ‘Adequacy and flexibility study for Belgium 2020 – 2030’] Probability matrix for flow based assignment in the Monte Carlo approach	25
Table 6 RES capacities in Germany.....	42
Table 7 Assumed reserves in Germany	42
Table 8: Reduced NTCs between Switzerland and its neighbours for the Low Nuclear / CH NTC sensitivity.....	45
Table 9 Low Gas sensitivity assumptions	49
Table 10: NTC for Switzerland in Sensitivity 2: Low Nuclear & Low NTC CH.....	50
Table 11: Average ENS and LOLE for the base case and the two sensitivities	52
Table 12: Impact of capacity reserves in Germany on the LOLE results in Germany and Luxembourg	58

1. Introduction

This report provides the main findings of the third edition of the Pentalateral Generation Adequacy Assessment (PLEF GAA 3.0). The study was carried out by the Transmission System Operators of the seven countries cooperating in the Pentalateral Energy Forum (PLEF): Austria, Belgium, France, Germany, Luxembourg, the Netherlands and Switzerland.

The Pentalateral Energy Forum is the framework for regional cooperation in Central Western Europe (AT-BE-DE-FR-LU-NL-CH) towards improved electricity market integration and security of supply.

This third edition of the PLEF Generation Adequacy Assessment, mandated by the Political Declaration of the Pentalateral Energy Forum dated 7 June 2013 in which the Ministers of Energy requested a Pentalateral Generation Adequacy Assessment, establishes some key features developed in the previous editions and elaborates them further. It continues to provide a probabilistic analysis on electricity security of supply in Europe focussing on a regional perspective, thus making it possible to better assess generation adequacy jointly, on a regional scale covering the PLEF countries.

In June 2015, the PLEF ministers defined in their 2nd Political Declaration further milestones on security of supply, on market integration and on flexibility, including the aim for further improvements of the common methodology to assess security of supply on the regional level as developed by the TSOs. PLEF TSOs continue to publish regular bi-annual reports on the status of security of supply in the central western European region, starting in 2017.

The declaration was followed-up by a roadmap that was prepared together with the PLEF TSOs defining the contents of the next adequacy study, taking into account important insights gained from the first two studies by the PLEF TSOs on needs to further improve the methodology of the assessments. After completion of the road map PLEF TSOs have intensively worked together to carry out the new study establishing an improved level in adequacy assessment.

Compared to the second assessment, the most important area of improvement is the establishment of the CWE 70% minRAM flow-based approach as the standard methodology. In the second edition, the flow-based methodology was implemented for the short term horizon 2018/2019 only since the modelling approach relied on historic data. This approach had to be enhanced in order to build up the flow based model for the time horizon 2025, where historic data could not be used any more to build the flow based domains. A description how those domains were created is provided later on in this document.

Another important improvement is the inclusion of hydrological data in the ENTSO-E Pan-European Climate Database (PECD). While in the second edition only three degrees of water availability were combined with all other input data, this third edition assigns a different one to each climate year. This is seen as a major data-related improvement from the perspective of hydro-dominated countries such as Austria and Switzerland. Furthermore, the climate database has been extended. For the third edition, it comprises the climate years 1982 to 2016.

The present report starts with the executive summary. Section 2 provides a short description of the general approach and the high-level methodology of the study. Section 3 provides detailed descriptions of the methodology and modelling assumptions. Section 4 provides detailed descriptions of input data by country. An overview of the base case scenarios and sensitivity analyses that were carried out is provided in section 5. The results of the adequacy analysis including also the investigation of the critical hours are reported in section 6, and conclusions and lessons learnt are presented in

section chapter 7. The appendix in section 8, contains details on the FB modelling, a glossary and a TSO contact list.

Comparability of Pan European, Regional and National studies

For consistent analyses and comparisons of the results a methodological alignment between pan-European, regional and the national studies is important. This regional PLEF GAA study, ENTSO-E Pan-EU study (MAF) and various probabilistic national adequacy studies by TSO, currently share a similar approach.

By means of example, a non-exhaustive list of relevant studies is given below. Although not all studies in the list below use exactly the same approach, the methodological alignment between these studies and the PLEF GAA 3.0 is significant:

- Elia Adequacy Study for Belgium: The need for strategic reserve for winter 2020-21 and outlook for 2021-22 and 2022-23²
- Elia Adequacy & Flexibility study for 2020-2030³
- RTE long-term adequacy study 2017⁴ and RTE mid-term adequacy study 2019⁵
- TenneT Rapport Monitoring leveringszekerheid 2018-2034⁶
- ENTSO-E Mid Term Adequacy Forecast 2019⁷, currently in consultation.
- Swissgrid for the National Regulator ElCom: System Adequacy 2020⁸
- Swissgrid for the National Regulator ElCom: System Adequacy 2025⁹

However, due to the different and complementary scope and usage of Pan-European, regional and national studies, some differences in the methodological assumptions and data might be considered between the above mentioned studies. Table 1 highlights some of the main differences observed between different adequacy assessments in Europe at present.

² <https://www.elia.be/en/electricity-market-and-system/adequacy/strategic-reserves>

³ <https://www.elia.be/en/publications/studies-and-reports>

⁴ Main results (eng) : https://www.rte-france.com/sites/default/files/bp2017_synthese_va.pdf ; Full report (fr) : https://www.rte-france.com/sites/default/files/bp2017_complet_vf.pdf

⁵ Main results (eng) : https://www.rte-france.com/sites/default/files/2019_generation_adequacy_report_-_executive_summary.pdf ;

Full report (fr) : https://www.rte-france.com/sites/default/files/bp2019_rapport_complet_1.pdf

⁶ Rapport Monitoring Leveringszekerheid 2019:

https://www.tennet.eu/fileadmin/user_upload/Company/Publications/Technical_Publications/Dutch/20200117_Rapport_Monitoring_Leveringszekerheid_2019.pdf

One pager in English:

https://www.tennet.eu/fileadmin/user_upload/Company/Publications/Technical_Publications/One-pager_Monitoring_leveringszekerheid_JAN2020_EN_2.pdf

⁷ https://www.entsoe.eu/outlooks/midterm/wp-content/uploads/2019/12/entsoe_MAF_2019.pdf

⁸ https://www.elcom.admin.ch/dam/elcom/de/dokumente/2017/Schlussbericht%20System%20Adequacy%202020.pdf.download.pdf/Schlussbericht_System_Adequacy_2020_-_Studie_zur_Versorgungssicherheit_der_Schweiz.pdf

⁹ <https://www.elcom.admin.ch/dam/elcom/de/dokumente/2018/Schlussbericht%20System%20Adequacy%202025.pdf.download.pdf/Schlussbericht%20System%20Adequacy%202025.pdf>

Report	Time horizons	Geographical perimeter	Climate Dataase	DSR	Flow Based method
MAF 2019	2021, 2025	EU	ENTSO-E PECD	DSR input from TSOs	Sensitivity for 2021
PLEF 2020	2025	EU, but with focus on adequacy within PLEF region. MAF data provides the basis for setting up the model outside of the PLEF region	ENTSO-E PECD	DSR input from TSOs	Usage of flow based approach for CWE TSOs including the 70% CEP effect and based on national studies methodological evolutions
Probabilistic national studies by TSOs, comparable to MAF 2019	Different, up to 10 years ahead	Single unit resolution within focus perimeter relevant for the study. Dataset consistent with MAF for rest of the simulation perimeter	ENTSO-E PECD and Hydro specific databases for all climatic years ¹⁰	Extensive consultation with market parties on national assumptions (e.g. DSR assumptions)	Flow based innovative approach based on calculated future domains including the 70% CEP effect.

Table 1 Features of regional and national analyses

¹⁰ For its national studies RTE uses a specific weather database provided by Meteo France which comprises 200 simulated years of the climate (temperatures, wind, solar radiation) over western Europe, and consistent with today's climate

Existing Adequacy Standards in PLEF

The adequacy standard that has to be met is normally set by each country, in case it is defined. For the moment, there is neither such definition for the PLEF region nor for the following PLEF countries: AT, CH, DE, and LU. A summary of existing standards in the PLEF countries is provided in Table 2.

PLEF Country	Adequacy Standard
BE	LOLE average of 3h/year & LOLE95 of 20 h ¹¹
DE	LOLE average of 5h/year ¹²
FR	LOLE average of 3h/year ¹³
NL	LOLE average of 4h/year ¹⁴
AT, CH, LU	n/a

Table 2 Existing Adequacy Standards in PLEF

¹¹ Belgian law of 26 March 2014 amending the Federal Electricity Act of 29 April 1999

¹² German adequacy criteria in paragraph 2.2 of the [German national adequacy report](#), which was used in the accompanying [study on definition and monitoring of security of supply](#) on the European electricity systems according to § 51 (4) of the German Energy Act; this criteria is not yet agreed with LU according to Art 25 (1) of the Electricity Market Regulation 2019/943, but the exchange is being initiated

¹³ French law February and August 2004

¹⁴ Dutch adequacy criteria in paragraph 3.1.1 of the [Dutch national adequacy report](#) (in Dutch 'Rapport Monitoring Leveringszekerheid 2019 (2018-2024)') TenneT TSO

2. General approach

The procedure implemented in this study can be divided into three major steps (see Figure 1): (I.), inputs are prepared, mainly covering electricity demand, renewables generation profiles, water availability, demand side response capacity, pre-installed power plant fleet, unscheduled generation unavailability and transmission capacities. (II.), constraints for the modelling of Flow-Based market coupling (FB Model) are determined. (III.), generation adequacy indicators are computed utilising two Generation Adequacy models (GA Models).

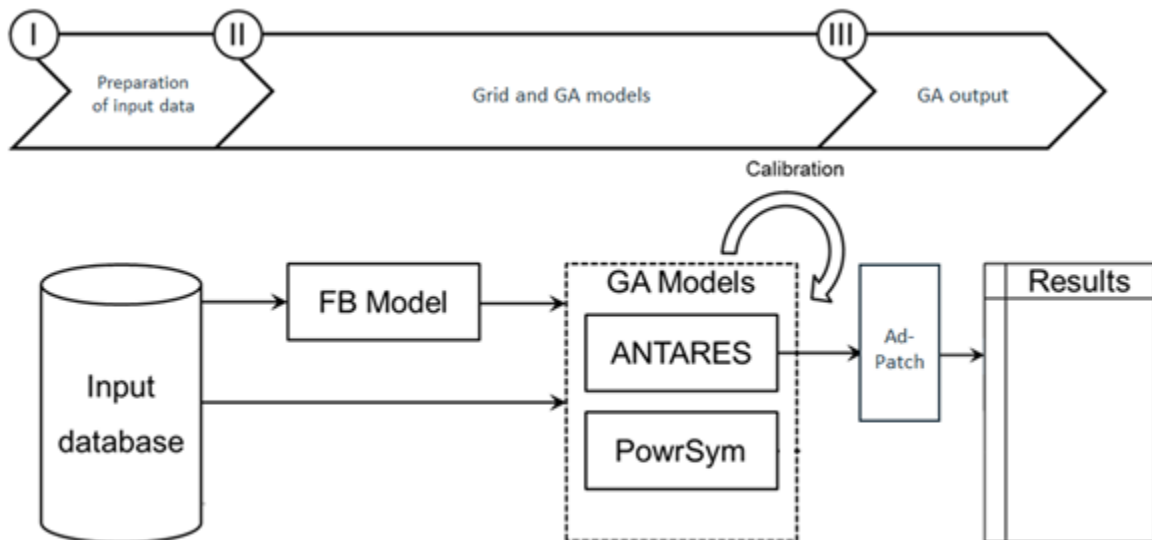

Figure 1 Process of study performance

According to Figure 1, multiple tools and models are utilized in this study. In order to increase the level of quality and robustness of the presented results two system models (ANTARES and PowrSym) are used in parallel for determining market results and generation adequacy indicators. While both models use the same input data and follow the same approach with regard to probabilistic modelling there are differences for instance regarding the formulation of technical restrictions, which might lead to deviating results. However, once the results of the two models converge well, they are used for the computation of the final results, by taking into account the so called Adequacy-Patch, which is described in detail in section 3.9.5. The final calculation with adequacy patch has been carried out with the ANTARES tool only.

The enhanced modelling of flow-based market coupling requires a determination of commercial transaction constraints based on relevant physical transmission constraints, which are described by the flow-based domains.

The three steps and underlying methodologies are described in more detail in the subsequent chapters. In chapter 3.1 the preparation of input data, e.g. the determination of temperature-sensitive load profiles, is briefly described. Chapter 3.8 gives an overview of the flow-based model and the derivation of the flow-based domains. Both generation adequacy models and considered uncertainties are further detailed in chapter 3.9, where the description of the relevant outputs and indicators used for the generation adequacy analysis can also be found.

3. Methodology

3.1 Preparation of input data

The preparation of the PLEF input data is done through a standard data gathering process based on the one used also for the ENTSO-E MAF study, with the necessary updates for the year 2025 by the PLEF TSOs concerning their national data. The scenario data have been presented to and approved by the PLEF ministries. The data collection represents the available information by the end of 2019.

Finally when assessing the results of the sensitivities, it should be noted that the assumed reduction of available power plants was an exogenous input from the respective national level.

No integrated economic assessment of power plant profitability for the Penta-region has been applied. Rather, the 'Scenario Building' process followed in this study aims to reflect Member State generation mix choices and best estimate decisions and identified risks.

3.2 Pan-European Climate Database

Weather conditions are becoming a more and more important element in the European power system. Dependency on weather is present on both supply and demand side. Important weather-related supply side uncertainties concern the production of wind, solar PV and hydro power. On the demand side, in many countries the temperature has a major influence on demand.

In certain situations, the system may become more vulnerable, for example, when there is low availability of conventional power and simultaneously low feed-in from renewables (RES). All this combined with a cold wave in Europe can cause a significant reduction of the adequacy margin. Because of the space- and time correlated nature of these weather related parameters, a correct assessment of the adequacy risks in such situations places high demands on the method of simulation. For this reason, ENTSO-E has improved the modelling of the weather dependent parameters by the development of an advanced Pan European Climate database (PECD). This development started within the framework Ten Year Network Development Plan (TYNDP) 2012 and continuously develops.

This PLEF study uses the 3rd release of the Pan European Climate database. This database enables the creation of correlated chronological time series of weather-dependent parameters (electricity demand and renewables production) per market area in Europe based on historical weather over the period 1982-2016 (35 climate years). An important enhancement of the PECD is the inclusion of water availability (historic reservoir inflow and various constraints associated with hydro reservoirs) for all 35 historic years. This allows taking into account the varying quantities of hydropower production depending on rainfall and snowmelt for each climate year.

3.2.1 Load

The hourly load data are taken from the ENTSO-E MAF 2019. The thermal sensitivity or temperature dependency of the hourly load is the same as the one applied for the MAF using the Pan European Climate Database (PECD). The approach applied in the MAF report entails a principal component analysis of the load curves from 2010 to 2016. The principal component analysis allows the construction of a normalized load profile, i.e. a load profile resulting for average conditions of every climatic parameter (wind velocity, irradiance, humidity and temperature). Another result is a set of regression factors relating the normalized load profile to these climatic parameters.

Assumptions regarding the future development of electric vehicles, heat pumps and various factors, e.g. the deployment of data centres adding baseload, or efficiency measures resulting in demand reductions, have been submitted by the TSOs during the recent ENTSO-E data collection. For each climate year, the normalized load profile and the set of regression factors is used to construct the load profile for a given climate year including these additional parameters.

3.2.2 Wind and Solar

Similar to the ENTSO-E MAF study, the Pan European Climate Database (PECD) for wind and solar production for each country is applied. The extended database is based on existing global climate reanalysis models and contains hourly climate data for 35 years (1982 to 2016). The used climate data consider climatic spatial and temporal correlations and allow a consistent set of load as well as wind and solar production time series for the subsequent adequacy simulations. Onshore, offshore wind and solar photovoltaic load factor (percentage of production compared to installed capacity) time series are given for each market node, and are scaled to the expected future installed capacity.

3.2.3 Hydro

Modelling a hydro production system, especially one including storage and pump storage power plants is challenging due to its complexity and the presence of many stochastic variables, e.g. cascades of reservoir basins and unclearly defined marginal costs. Therefore, some simplifications have to be made.

Nevertheless, the consideration of hydrological conditions is enriched compared to the last PLEF adequacy assessment. The PLEF study uses new information made available by the Pan-European Market Model Data Base collected within current ENTSO-E studies (MAF2019 and TYNDP2020). Indeed, each Transmission System Operator not only delivers three hydrological data sets corresponding to dry, average, and wet conditions, but allocates explicit hydro inflow profiles to each climate year (1982 – 2016) as in the Pan-European Climate Database (PECD). This allows a better consistency between all climatic variables (temperatures, wind, solar radiation and hydro conditions).

The new data collection (using ENTSO-E templates) classifies the hydro generation fleet in four categories, each having a set of specific constraints. The four categories are *i) run of river and swell*, *ii) traditional reservoir*, *iii) pumped storage open loop* and *iv) pumped storage closed loop*. The criteria for hydro power plant classification and some key modelling guidelines are given below:

- Run of river and swell plants that do not have pumping capacity, do not have reservoirs, or have small reservoirs with a maximum of 24 hours of storage. (Reservoir Capacity / Net Generating Capacity \leq 24 hours). This new category merges all the run of river and swell units of a given market node in a single “must-run” unit with a predefined generation availability time-series provided by each TSO as daily inflows for each climate year. As reported in the PECD description, the calculation of natural inflows for past climatic conditions was done based on statistical reanalysis correlating historical water volumes (m^3/day) flowing in rivers with the corresponding hydropower production (GWh) for a number of sample years. The transfer function resulting from this process was applied to historical water volumes (m^3/day) for other years, hence inferring the corresponding energy inflow availability (GWh).

For the storage types of hydro generation, the final dispatch results from an economic optimization as well as a heuristic allocation (in ANTARES) of the yearly or monthly available inflows, following the

corresponding demand profiles. At the same time, they are subject to several additional constraints, including minimum and maximum reservoir level trajectories. The optimal “Unit Commitment and Economic Dispatch” solution is determined by the solver considering hydro storage and thermal unit availability, with the aim of minimizing the overall system cost. In these regards, hydro storage generation and especially pump storage production is subject not only to the natural inflows available, but also to price and market signals. The main characteristics and constraints of the hydro storage categories are the following:

- *(Traditional) Reservoir*: hydro power plants that have reservoirs, but do not have pumping capacity. The storage capacity must be higher than 24 hours. (Reservoir Capacity / Net Generating Capacity > 24 hours). Natural inflows to the reservoir are available on a weekly basis, as well as the minimum and maximum power output and reservoir level trajectories, which further constraint this type of generation. The category *Reservoir* only subsumes hydro storage units without pumping capacity.
- *Pumped storage open loop*: hydro power plants that have pumping capacity in place, irrespective of the reservoir size, whereas they still have natural inflows, reservoir trajectories and minimum and maximum generation are treated similarly to the reservoir category, whereas additional constraints apply, including the minimum and maximum pumping power [MW]. An efficiency rate of 75% is assumed by the model as standard efficiency of the PSP cycle, i.e. the model can retrieve 75% of the energy absorbed by the pumping capacity. The model seeks the best opportunity for pumping (when costs/prices are low) and for generation (when prices are high) in order to minimize the overall costs of the system.
- *Pumped storage closed loop*: hydro power plants that have pumping capacity/technology in place, irrespective of the reservoir size, and that do not have natural inflows. They are subject to similar constraints as the *pumped storage open loop* category, with the only difference being the absence of natural inflows.

3.2.4 Thermal units and outages

Installed capacities for thermal units are based on ENTSO-E data, with the necessary updates by the PLEF TSOs for their national data. For thermal units, different categories are defined (coal, gas, etc.) in accordance with the definitions in the ENTSO-E’s Pan-European market model database (PEMMDB). Each category has parameters defining the main technical and economical characteristics, like maximum power, fuel type, efficiency, fuel cost, operation and maintenance cost, etc.

Each thermal unit is given a rate of unavailability (forced outage and maintenance rate and durations) that is based on the type of the unit. When no specific data is proposed by the TSO, this information is taken from the PEMMDB of ENTSO-E where default values based on historically observed unavailabilities are available.

The maintenance schedules used in PLEF are taken from the MAF study (adapted when differences exist on installed capacities for the PLEF region). Such maintenance schedules result from an optimization, which defines maintenance periods throughout the year. Such optimizations respect the minimum maintenance level set for each season (winter/summer) by TSOs within the PEMMDB.

Maintenance plans determination in pan-European studies is clearly a field where modelling improvements could be implemented, to better translate not only the rationale of the maintenance

from plant operators (maximize availability on peak period), but also the risks attached to maintenance (for example the risk of an extended duration of a maintenance due to unforeseen reasons). This would require an enhanced data collection and some complementary efforts in modelling.

On top of this maintenance, the simulators apply random draws to account for forced outages, thus producing different combinations of outages.

3.3 Outages of HVDC lines

In line with the MAF, forced outages due to unexpected failures of HVDC links resulting in unavailability of these transmission links have been taken into account for selected High-Voltage Direct Current (HVDC) interconnections in the CWE perimeter. It has been considered that a forced outage of these links will occur with a chance of 6% for a period of 7 consecutive days.

3.4 Fuel and CO₂-prices

The assumptions on fuel and CO₂ prices for this study were taken from the same source as used in the scenario building of ENTSO-E in 2019 MAF as well as 2018 TYNDP¹⁵ edition namely PRIMES data. The choice of PRIMES fuel costs was an agreement of ENTSO-E together with the European Commission and ACER through a co-operation platform.

The development of the energy sector and its markets is affected by many different uncertainties. The government policies of the different countries are a major driving force, which is shaping the development of the energy sector.

The corresponding values are presented in Table 3: EU fuel and CO₂ prices of PRIMES

Unit	Fuel type	2021	2025
€/GJ	Nuclear	0,5	0,5
€/GJ	Lignite	1,1	1,1
€/GJ	Hard coal	3,2	3,8
€/GJ	Gas	5,8	6,5
€/GJ	Light oil	14,1	18,8
€/GJ	Heavy oil	11,1	13,3
€/GJ	Oil shale	2,3	2,3
€/tCO ₂	CO ₂ price	20,4	23,0

Table 3: EU fuel and CO₂ prices of PRIMES

In European power markets generation units are dispatched according to their marginal generation costs. Besides variable costs for maintenance, marginal costs are mainly determined by fuel and CO₂-prices. Accordingly, the merit order of generation units (without costs due to technical constraints), i.e. starting from the technology with the lowest cost, determines the cost minimal dispatch.

3.5 Perimeter

The perimeter covered in this study is shown in Figure 2 below. The blue highlighted countries represent the main focus area. The green highlighted countries are also considered in the models to im-

¹⁵ <https://www.entsos-tyndp2020-scenarios.eu/fuel-commodities-and-carbon-prices/>

prove the representation of the focus area. The perimeter configuration follows the MAF 2019 approach.



Figure 2 Perimeter of the modelled countries in this study

3.6 Balancing Reserves

The total volume of balancing reserves has been provided by TSOs via the MAF 2019 data collection. A revision of these figures was performed within the CWE by PLEF TSOs. Reserves include both Frequency Containment Reserves (FCR) and Frequency Restoration Reserves (FRR). The figures and the approach on the modelling are listed in Table 4 . The amount in MW is either directly given or can be easily derived by multiplying the percentage with the total installed capacity of the corresponding category on the generation type for the PLEF countries.

These reserves are modelled in the following way:

- Reserves on hydro units – reduction of turbine capacity
- Reserves on thermal units – reduction of the thermal capacity among the relevant categories
- Extra load – In case the first two options are not applied, the load of the respective country is increased

An overview is provided below for the PLEF countries:

Country	Reduction Hydro [MW]	Thermal Reduction [MW]	Extra load [MW]
AT	513	0	31
BE	0	0	500
CH	869	0	0
DE ¹⁶	0	0	4950
FR	571	1500	0
NL	0	0	800

Table 4 Balancing reserves for 2025 horizon

3.7 System Adequacy Mechanisms

Within the PLEF area different types of System Adequacy Mechanisms are implemented in some countries, while some others rely on the energy only market (EOM). These mechanisms are typically designed to ensure either generation adequacy or transmission adequacy.

To analyse whether the capacities contracted in these System Adequacy Mechanisms should be considered in the assessment, differentiation between mechanisms is made, which

a) ensure the availability of sufficient capacity in the market to cover peak demand in all future situations, given a predefined threshold expressed by the country reliability standard (generation adequacy), by contracting resources in a capacity market (CM) or strategic reserve (SR). These are referred to 'Capacity Remuneration Mechanisms' by the EC within State Aid Guidelines and in the CEP.

and

b) ensure the availability of additional generation capacity in case of grid congestion (transmission adequacy). These capacities are then contracted in a grid reserve (GR) and need to fulfil certain requirements by means of e.g. grid topology and ramp-up times, so that they have an effective impact to cure the grid congestion.

¹⁶ Includes Luxembourg balancing reserves

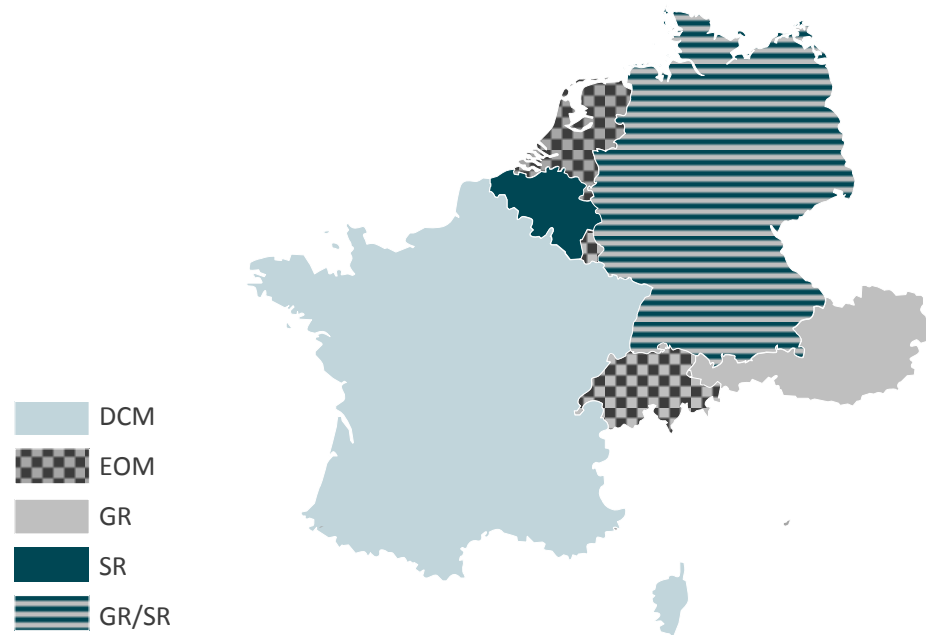

Figure 3 System adequacy mechanisms (in place or under development) in Central Western Europe

The described types of System Adequacy Mechanisms have predefined triggers and dispatch regimes, generally stated in the national energy laws.

In the following, the System Adequacy Mechanisms implemented in the PLEF countries are described as well as to what extent the CRMs are considered when analysing generation adequacy in the countries of the region. According to the information and legal basis known at the point of time of the study the assumed capacity available in 2025 is incorporated.

Only System Adequacy Mechanisms that contribute to the assurance of the generation adequacy, hence 'Capacity Remuneration Mechanisms', will be taken into consideration in the study.

3.7.1 Austria

In Austria generation capacity was contracted as grid reserve for redispatch measures in case of critical network congestions until 2021. Since no contracts are available until 2025, in the current PLEF study we follow an optimistic approach, so the originally contracted plants for 2025 are assumed to be still available.

3.7.2 Belgium

In Belgium, a strategic reserve mechanism is in place since 2014 and has been approved under the European Commission's State Aid guidelines until winter 2021/22. It foresees the possibility to activate out-of-market capacity when a risk of structural shortage is detected. Structural shortage refers to a situation in which the total consumption level of Belgium, cannot be covered by the offer of installed production in the Belgium control zone, excluding the contracted Balancing Reserves, including the importation possibilities and the energy available on the market (defined in Belgium's Electricity Act, art; 2,54°). In the most recent volume assessment of strategic reserves (November 2019, see footnote), there was no need identified for the following winter. The public authorities have thus decided not to constitute a strategic reserve for winter 2020/21. Therefore and given that for the next time horizon of this PLEF's adequacy study (i.e. 2025) there is, at this moment in time, no Strategic Reserve foreseen in Belgium, but rather a market wide CRM (cf. below), hence no strategic reserve capacity is considered in this studies' simulations for Belgium. It is worth noting that all existing

units are assumed to be available in 2025 for the present study (unless a closure announcement has been notified by the owner).

Previous adequacy studies performed for Belgium have all concluded that Belgium will deal with serious security of supply issues as of 2025, due mainly to the phase-out of nuclear capacity and the energy transition evolutions in neighbouring countries. It was also established that this creates a significant need for new capacity, as the existing capacity in addition with ambitious assumptions regarding import and for future capacity developments like Demand Response or RES prove insufficient to cover the future needs. Note that even, albeit smaller new capacity needs are already foreseen as of winter 2022/23 based on the latest adequacy studies for Belgium.

In the most recent study performed by Elia in June 2019 (Elia study 2019, see footnote 3), the adequacy need was again confirmed. This study is used as centrepiece by the Belgian authorities in the framework of the Belgian CRM notification file towards the European Commission to foresee a market-wide CRM as of 2025.

European Commission sector inquiry finds that where a MS identifies a LT risk that there will be insufficient investment (as is the case for Belgium), market-wide Capacity Mechanisms are likely to be the most appropriate form of intervention and where a MS identifies a temporary risk, a Strategic Reserve is likely to be the most appropriate form of intervention. Whilst strategic reserves are able to address temporary shortages, they do not address underlying market failures, it only corrects missing money problem for selected capacities. Note also that Strategic Reserve relies on capacity held outside of the market and primarily aims at avoiding that capacity exits the market rather than attracting new capacity to enter.

This is just one of the reasons why the Belgian State has adopted a federal law, foreseeing the introduction of a market wide, technology-neutral and centralised CM for Belgium with first delivery year in 2025. This is currently being investigated by the European Commission in the framework of the State Aid Guidelines. As explained in section 6.6.2 'Disclaimers and TSO Comments on results / Belgium', for 2025 a need of 2.5 GW new capacity is thus assumed in this study to be delivered under the CRM in 2025 in order to reach adequacy for Belgium (based on the 'EU-BASE' scenario of the Belgian 10-year adequacy study). Furthermore, it should be noted that in the same study a volume of 3.9GW new capacity has been identified to ensure an adequate Belgian system and cover for uncertainties which are 'beyond control' of Belgium after 2025.¹⁷

3.7.3 France

The (decentralized) capacity mechanism became operational in France in 2017. It is not explicitly modelled in this PLEF GAA study, but is implicitly reflected in the input data. The resource capacities (generation and demand-side flexibilities) in the dataset for France in the medium term are the best estimate values as foreseen by RTE at the time of the data collection. The assumptions are thus based on analyses of the existing units, the objectives set by the NECP and the announcements of the operators for this period. The latter dimension is indeed subject to a public consultation, as part of the national adequacy studies by RTE, where French market stakeholders participate to share their visions for the years to come. The impact of the French capacity mechanism has therefore been tak-

¹⁷ This is 2.4 GW 100% available which is here assumed to be 2.5 GW thermal generation. The choice of technology was arbitrary.

en into account by French market stakeholders themselves and is reflected in the assumptions of this study. Besides, economic analyses in the last French report “Bilan prévisionnel de l’équilibre offre-demande d’électricité en France¹⁸” from 2019 have shown (see the extract below in Figure 4) that the capacity mechanism is important to ensure the continuing availability of some assets contributing to the security of supply (OCGT and even CCGT).

Figure 26. Net annual revenue (i.e. market revenue minus variable production costs)⁹ for gas-fired combined cycle and combustion turbine plants from 2015 to 2019 and comparison with fixed cost assumptions¹⁰

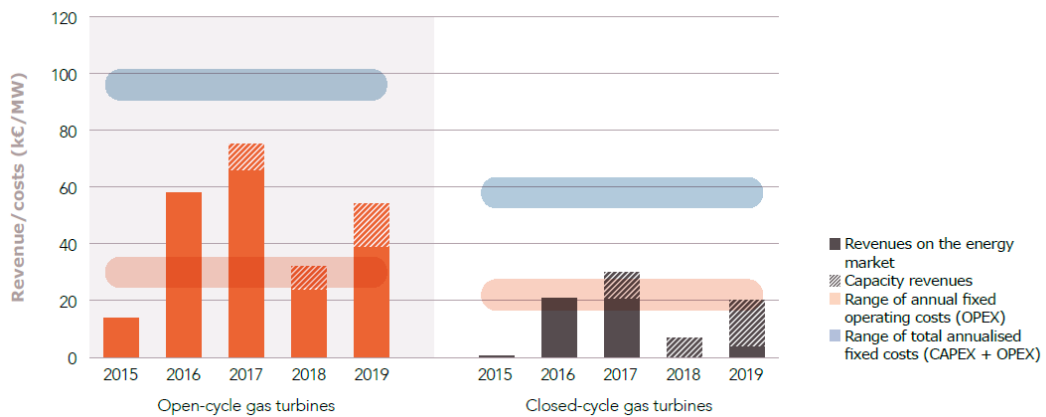

Figure 4: [Figure taken from ‘Bilan prévisionnel de l’équilibre offre-demande d’électricité en France’] Net annual revenue for gas plants from 2015 to 2019

Besides, calls for tenders, known as "AOLT" in France, were launched by the French Ministry of Energy in 2019 to develop new capacities from low carbon technologies to contribute to the security of supply, in accordance with the expectations of the European Commission. The volume of new capacities selected, for which the level of capacity remuneration is guaranteed for seven years, is 377 MW (253 MW of batteries and 124 MW for demand-side response) and will be available from 2021 and 2022 onwards. Since the outcomes of the calls for tender have just been published by RTE in February 2020, these new capacity volumes have not been considered in the PLEF GAA study.

3.7.4 Germany

In Germany there are three different reserve mechanisms implemented by the revised German Energy Law (EnWG) in 2016, which aim to support different objectives. The EnWG offers two kinds of strategic reserves in order to deal with adequacy issues in Germany, the “Security Reserve” and “Capacity Reserve”.

The capacity of the Security Reserve consists of lignite power plants. The amount of capacity in this reserve was built up from October 2016 onwards to a maximum amount of 2.7 GW in 2019/20. It will be faded out completely in October 2023 (0 GW). For 2021 it will be round about 2 GW. The Security Reserve is not incorporated in the base case of this study.

¹⁸ https://www.rte-france.com/sites/default/files/bp2019_synthese_12_1.pdf

The Capacity Reserve was tendered in winter 2019/20 for a time horizon of 2 years, beginning in October 2020. In total 1GW of capacity was contracted by the German TSO. It can be assumed, that 2GW will be contracted by 2025.

The third element under the EnWG allows contracting of a Grid Reserve by the German TSOs. The Grid Reserve may be activated by TSOs primarily for redispatch in case of network congestions in Germany. At the point of time of this study, 6.8 GW of Grid Reserve were contracted by the German TSOs. The power plants contracted are located in Germany. Due to the primary purpose of securing redispatch potential with regard to transmission adequacy, the capacities of the grid reserve are not incorporated in the base case, meaning that the respective capacities do not contribute to generation adequacy.

All three aforementioned reserves are not allowed to participate in the energy market. Therefore, the related generation capacities should not be considered in the base case data of this study. For the Security Reserve and the Grid Reserve this is the case. As the data collection for this study took place before the Capacity Reserve was contracted, a share of the related capacities is included in the base case. More detailed information about this can be found in the Country Specifics for Germany in section 4.4.

3.7.5 Luxembourg

Luxembourg has an energy-only market. At this point of time there is no CM installed.

3.7.6 Netherlands

The Netherlands have an energy-only market. At this point of time there is no CM installed.

3.7.7 Switzerland

Switzerland has an energy-only market. At this point of time there is no CM installed.

3.8 Grid modelling

This PLEF study establishes flow-based grid modelling as the standard approach for the CWE Flow Based Market Coupling (FBMC) area. For other borders that are not part of the FBMC area, the "Net Transfer Capacity" model (NTC) is used. The FB model that is used in this study was developed by Elia. This model will be further enhanced within the future European Resource Adequacy Assessment (ERAA).

3.8.1 NTC vs. FB Model

The long term planning NTC values provide a good, yet simplified, representation for the long term horizon one or more years ahead. These NTC values might differ from actual capacities encountered in operational time frame. In this sense, the flow-based modelling provides a more accurate representation of what is observed in the operational time frame. The flow-based values aim to indicate a more correct picture of the physically available transmission capacities since these values also consider the exchanges between other countries and take the grid situation better into account. A fully fledged flow-based methodology is more accurate and closer to reality of grid operation, this should be the preferred approach when possible.

Deviations of transmission capabilities under the flow based approach from the fixed NTC values can therefore go in both directions. On the one hand, due to synergies across several borders, capacities

can increase under flow based while, on the other hand, usually in times of scarcity and tight grid situations, capacities are lower than the respective NTC values.

As shown in, Figure 5 this is a fundamental difference between the NTC and the FB modelling approaches. In moments of simultaneous scarcity for countries A and B the market will try to maximally use all available transmission capacity, hence maximize the imports towards country A and B simultaneously. This indicated in Figure 5 both for NTC and FB by the 'transition' from light green dots towards the dark green dot for which A and B can import both simultaneously what is maximally possible. While in NTC approach, the cross-border transmission capacity is independent of the level of import/export of the corresponding market zones, in the FB approach the cross-border transmission capacity and the import and export positions of the market zones are coupled. The FB approach explicitly captures the link between the injections and extractions of power at the different nodes in the grid after-market dispatch and the different flow patterns within the underlying topology of the physical grid.

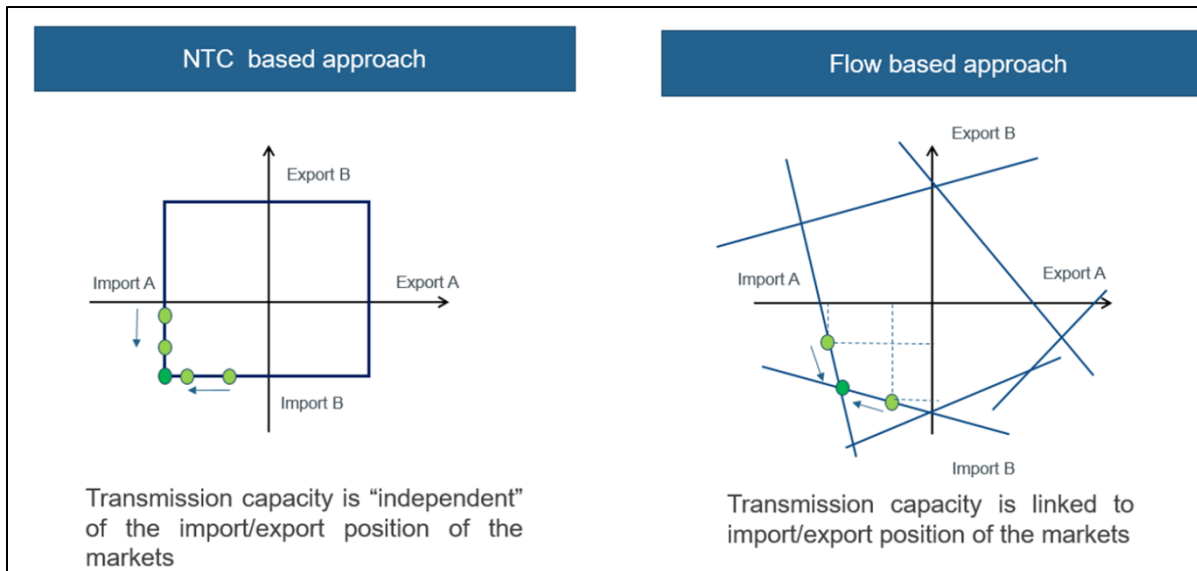

Figure 5 NTC vs FB

Regulation EU 2015/1222 on Capacity Allocation and Congestion Management (CACM) sets the flow-based method as the target model for Europe.

3.8.2 CWE Flow-Based Model

The commercial exchanges between the CWE countries are in operations limited by so-called flow-based domains. For short-term studies (e.g. previous PLEF 2017 Scenario 2018/19) the used flow-based domains are generally based on historical data.

However, for mid- and long-term studies the historical approach is no longer appropriate due to several expected changes in future years that need to be incorporated in order to obtain representative exchange capacities (including new rules, grid reinforcements, evolved generation mixes, etc.).

Therefore, a methodology has been developed by Elia and applied in its latest 'Adequacy and flexibility study for Belgium 2020 – 2030' report¹⁹ to create flow-based domains for a given target year on the mid- and long-term. This section gives a high-level overview of the developed methodology. For

further details, please refer to Chapter 2.7 of the ‘Adequacy and flexibility study for Belgium 2020 – 2030’ report²⁰.

General Approach and Assumptions

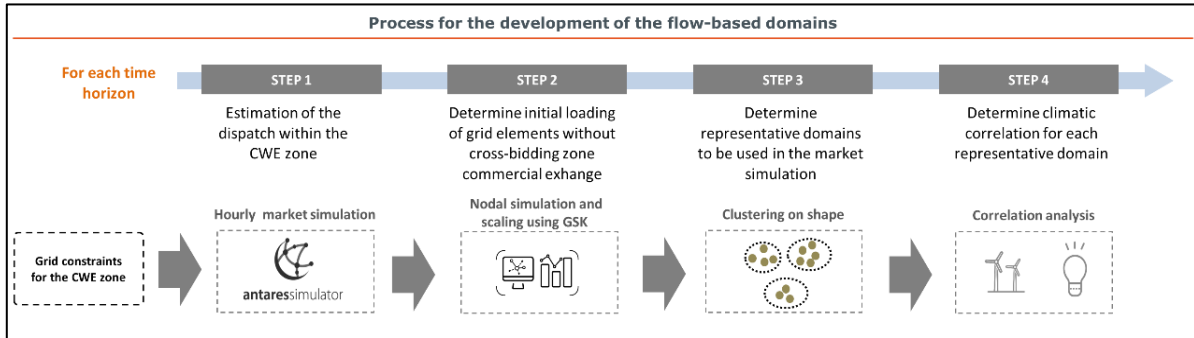

Figure 6 [Figure from ‘Adequacy and flexibility study for Belgium 2020 – 2030’] Overview of the different steps in the process of the determination of the flow-based domains

The following text below between [...] is taken directly from Chapter 2.7 of the ‘Adequacy and flexibility study for Belgium 2020 – 2030’²⁰.

[..

STEP 0

The flow-based domains are constructed based on grid constraints, representing the limits of the network elements. For this study, a European grid model developed in the context of the ENTSO-E Ten Year Network Development Plan (TYNDP) was used. The TYNDP “reference grid” was used which is based on the expected grid for 2027. This assumption provides an optimistic view on the commercial exchange capacity for the studied horizon of 2025 as foreign grid reinforcements might already be taken into account which are not planned to be realised by 2025 but rather 2027.

The flow-based domains constrain the 6 variables of the CWE zone: the CWE balance of the 5 bidding zones (BE-NL-FR-DE/LU-AT), and the setpoint of the ALEGrO HVDC interconnector. For this study, only cross-border elements are retained to potentially constrain the commercial exchanges. Apart from the previous remark on grid reinforcements in the used TYNDP grid model, this assumption is a second reason why the created domains might depict a rather optimistic view on the future. All grid elements are considered to be available for the whole year. As grid maintenance is usually scheduled outside of the winter period when scarcity issues arise, this is a good assumption for adequacy studies.

Exchanges with countries outside of the CWE zone are modelled as NTCs hence assuming standard hybrid coupling (SHC). As a domain in more than two dimensions cannot be visualized, in this report the projection of this domain onto the Belgian-French plane is depicted further below (Figure 7), as Belgium and France are usually linked in terms of scarcity events and both are relying on imports to guarantee adequacy .

STEP 1

Using these domains, a first market simulation in ANTARES is performed, taking into account for each grid element its entire seasonal rated capacity. In this simulation, PSTs are used up to 2/3 of their tap

²⁰ Adequacy and flexibility study for Belgium 2020 – 2030 (<https://www.elia.be/en/publications/studies-and-reports>)

range in order to optimize the market welfare. This market simulation gives an estimation of the dispatch within CWE, with the goal of determining realistic initial loadings of all grid elements in the market coupling.

STEP 2

In a next step, combining geographical information on the location of load and generation within CWE with the hourly market dispatch from STEP 1, the loadings of grid elements associated with the hourly commercial exchanges resulting from the market simulation in STEP 1 can be determined for each hour. However, for the market domain initial loadings of grid elements without any commercial exchange are required. Using the bidding-zone Generation Shift Keys, based on dispatchable generation inside each bidding-zone, the net position of each of the bidding zones is scaled to zero. Hereby, commercial exchanges between bidding zones are cancelled, and the remaining flow on grid elements equals the initial loadings (internal flows and loop flows). The process used to scale bidding zones net positions to zero is the same as the one used in flow-based operations today.

Such initial loadings could potentially pre-use a significant portion of the physical capacity of grid elements, and thereby restrict market operations. As from 1 January 2020, Article 16 ((8) - 70 % min. capacity provision of Regulation EC 2019/943 will be applicable. In this regulation, specific requirements related to the availability of transmission capacity for market exchanges are introduced. To model the application of those rules for future time horizons, minimal margins are applied to each grid element determining the created flow-based domains. The CEP target for 2025 is 70%.

Minimal margins (CEP), feasibility of market outcome, and redispatching

[Box taken from 'Adequacy and flexibility study for Belgium 2020 – 2030']

In order not to let trades within one bidding zone limit cross border trade, minimal margins are applied on all network elements. At the moment, in the CWE FB market coupling a minimal margin of 20% is applied to constraining network elements during the flow-based capacity calculation. As specified in the 'Clean Energy Package' regulation (see some extracts of relevant parts of the regulation below), these margins are supposed to reach 70% by 2025, however derogations and action plans are possible to stepwise increase the currently applied margins to 70% in 2025 at the latest. In the present study, the applied minimum margin of 70% was considered for 2025.

The minimal margins are applied for the commercial exchange capacity calculation, and therefore could increase commercial exchange capacities beyond what is physically feasible. Therefore, the resulting net positions of the bidding zones might not reflect a secure grid situation, and significant redispatching could be required. For the present study the physical feasibility of the market outcome (including the availability of the resulting dispatch requirements that would be needed to secure this feasibility) is taken as given, and such analysis is outside of the scope of this GAA.

CEP Article 16 General principles of capacity allocation and congestion management

[...]

8. Transmission system operators shall not limit the volume of interconnection capacity to be made available to market participants as a means of solving congestion inside their own bidding zone or as a means of managing flows resulting from transactions internal to bidding zones. Without prejudice to the application of the derogations under paragraphs 3 and 9 of this Article and to the application of Article 15(2), this paragraph shall be considered to be complied with where the following minimum levels of available capacity for cross-zonal trade are reached:

- (a) for borders using a coordinated net transmission capacity approach, the minimum capacity shall be 70% of the transmission capacity respecting operational security limits after deduction of contingencies, as determined in accordance with the capacity allocation and congestion management guideline adopted on the basis of Article 18(5) of the Regulation (EC) No 714/2009;
- (b) for borders using a flow-based approach, the minimum capacity shall be a margin set in the capacity calculation process as available for flows induced by cross-zonal exchange. The margin shall be 70% of the capacity respecting operational security limits of internal and cross-zonal critical network elements, taking into account contingencies, as determined in accordance with the capacity allocation and congestion management guideline adopted on the basis of Article 18(5) of the Regulation (EC) No 714/2009. The total amount of 30% can be used for the reliability margins, loop flows and internal flows on each critical network element.

STEP 3

As the market simulation performed in STEP 1 creates an estimation of the dispatch and corresponding initial loadings within CWE for each hour of the simulated year, this would result in 8760 different flow-based domains. For the present study, it was chosen to limit the amount of flow-based domains to three for each time horizon in order to obtain feasible computation times and to increase transparency on the model. First, a clustering algorithm based on the geometrical shape of the domains is applied in order to create three clusters. Next, a representative domain is selected for each clustered set of domains leading to three representative domains to be used in the model. Figure 7 shows the resulting three flow-based domains for the 2025 horizon.

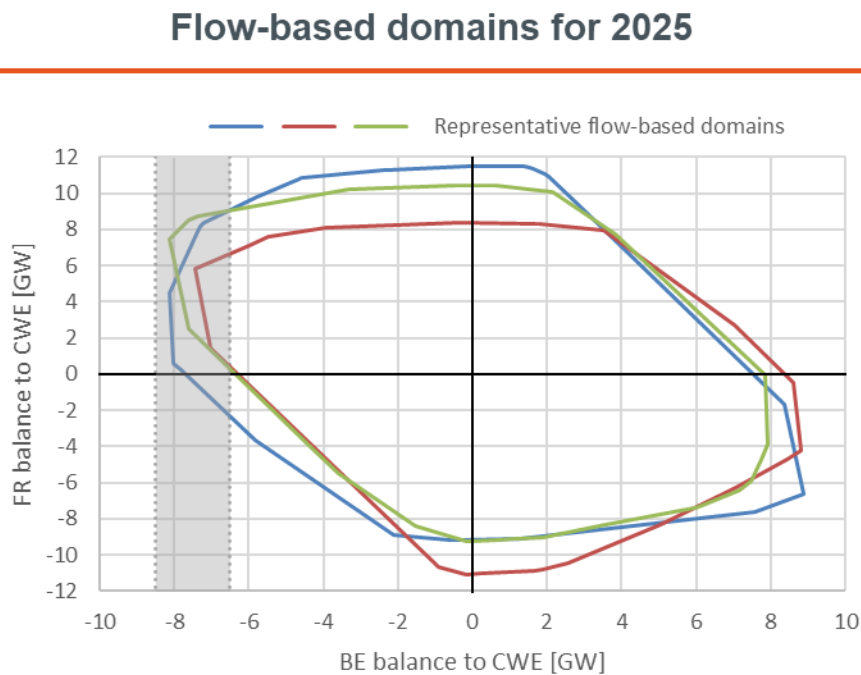

Figure 7: [Figure from 'Adequacy and flexibility study for Belgium 2020 – 2030'] Belgium France domain

STEP 4

In a final step, for each time horizon, a correlation analysis between the three domain clusters and several input parameters was applied in order to link a given market situation to the flow-based domain to be applied. This analysis resulted in the selection of German wind infeed and French consumption as the most relevant parameters in determining the selection of the domain. Therefore, in the final simulations the hourly choice of the applied domain is based on this correlation with said external parameters. As an example, Table 5 gives the probability for each representative domain to occur depending on the climatic conditions for 2025.

Probability for each representative domain to occur depending on climatic condition for 2025

		German wind		
		High	Medium	Low
French load	High	(0.12, 0.69, 0.19)	(0.45, 0.27, 0.27)	(0.58, 0.18, 0.24)
	Medium	(0.24, 0.53, 0.24)	(0.48, 0.24, 0.27)	(0.67, 0.08, 0.24)
	Low	(0.32, 0.25, 0.43)	(0.43, 0.15, 0.43)	(0.47, 0.11, 0.42)

(x,y,z)
x = Probability of representative domain 1
y = Probability of representative domain 2
z = Probability of representative domain 3

Table 5: [Table from 'Adequacy and flexibility study for Belgium 2020 – 2030'] Probability matrix for flow based assignment in the Monte Carlo approach

..]

The text above between [.. ..] is taken directly from Chapter 2.7 of the 'Adequacy and flexibility study for Belgium 2020 – 2030'²⁰.

3.8.3 Import/Export capacity for areas outside the FBMC area: NTC approach

The PLEF countries and their neighbouring countries are interconnected and modelled via market nodes. Due to the integration of national power markets and in order to model cross-border aspects of generation adequacy, a pan-European model is considered in this study. NTC-values are taken from the ENTSO-E data collection based on TSO expertise (bottom up data collection).

The NTC values are defined based on expert view between TSOs and mainly derived from available data of previous studies for ENTSO-E. One fixed value is chosen (for each direction when relevant) for the whole year. Every country involved in this study has also the option to define a so-called simultaneous import and export capacity, with the aim to e.g. capture operational constraints, which might impact the import and export levels possible.

The chosen starting points are the bilaterally agreed transmission capacity for the MAF 2019 report 2025 scenario. The MAF 2019 NTC values are published²¹; the PLEF TSOs used them as a starting point because they are the most recent values for the entire European perimeter.

The modelling of Luxembourg and the interconnections to the neighbouring countries is rather specific in flow-based market coupling. Luxembourg (LU) is modelled by 3 different nodes namely LUg, LUf, and LUb. The public grid operated by the Creos Luxembourg is represented by the node LUg. This node interconnected to the German and Belgian grid is the relevant node representing the load and generation of Luxembourg (LU) to be considered in the adequacy assessment. As Luxembourg is part of the German-Luxembourgian bidding zone, the capacity of these cross-border lines linking

²¹ <https://www.entsoe.eu/outlooks/midterm/main-findings-of-maf-2019/>

both nodes DE and LUg is not commercialised and thus not reflected in the flow-based model. The interconnection with Belgium is currently not commercialised neither. The commercialised capacity between LUg and BE is thus 0 MW. Two additional nodes LUf and LUb representing the industrial load connected to France and Belgium are not link to the previous node LUg. LUf and LUb are not interlinked neither. The industrial load, mainly steel factories and electric furnace, connected to France are to be considered as load connected directly to France respectively Belgium. The thermal capacities of the connecting lines are not limiting the supply of these connected grid users. In the following we will refer with “LU” to the node “LUg” unless stated differently.

3.9 Generation Adequacy Models

The methodology used to assess the security of supply relies on the use of two advanced tools: AN-TARES and PowrSym.

Both tools use a probabilistic approach where future supply and demand levels are compared by simulating the operations of the European power system on an hourly basis over multiple years. These simulations take into account the main contingencies susceptible of threatening security of supply, including outdoor temperatures (which result in load variations, principally due to the use of heating in winter), unscheduled outages of nuclear and fossil-fired generation units and HVDC links, variable amount of water resources, wind and photovoltaic power production.

A set of time series, loads on the demand side and available capacity of units generating supply reflecting various possible outcomes are created for each of the phenomena considered. These time series are then combined in a sufficient number to give statistically representative results regarding shortages (risk of demand not being met due to a lack of generation) and annual energy balances (output of different units and exchanges with neighbouring systems).

A summary of the methodology is shown in the following Figure 8.

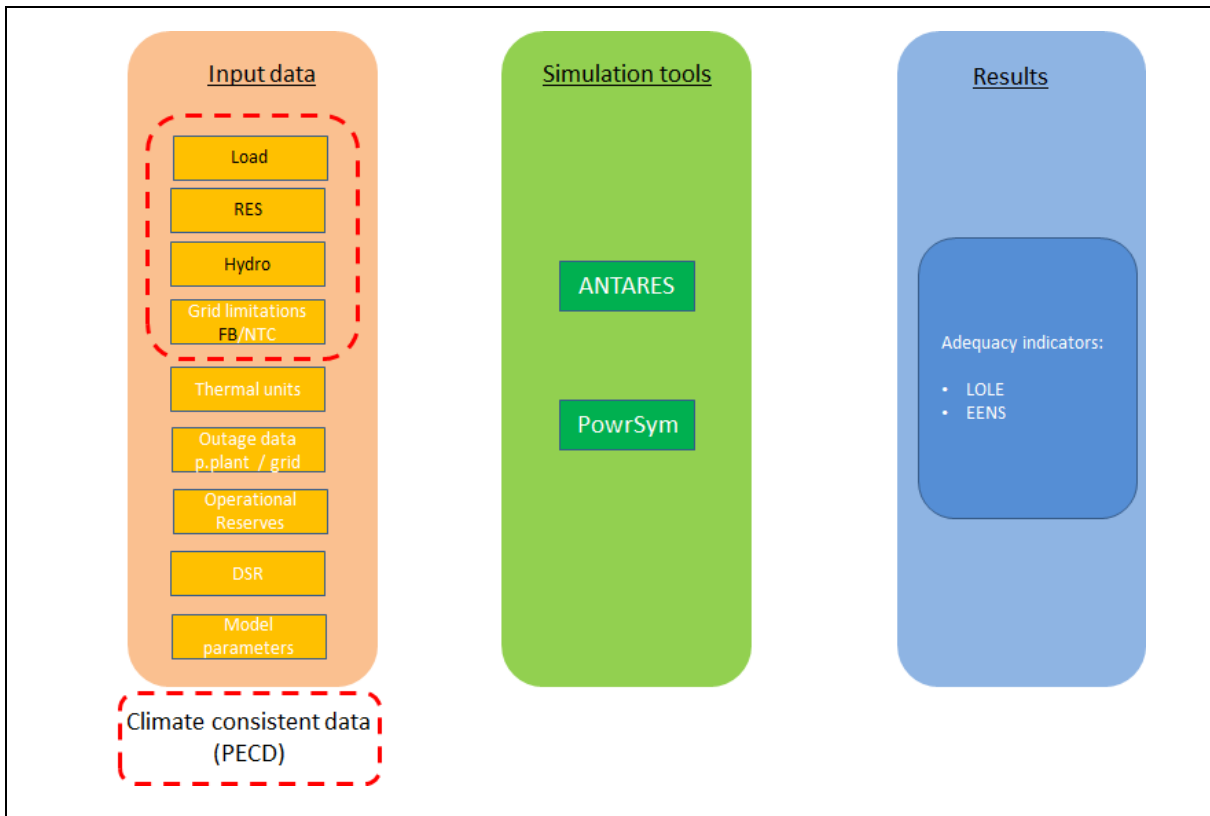

Figure 8 Methodology of combining various possible outcomes to achieve statistically representable results

The following paragraphs provide the rationale behind the PLEF simulation tools, the definition of the adequacy indicators computed, the principle of the Monte Carlo approach and its convergence. Finally, the benefits brought by the usage of two tools to conduct this study are presented.

3.9.1 Advanced tools

In this chapter, only a general description of the tools employed for the PLEF adequacy analyses is given. For the specific features of each individual tool please refer to the Appendix of the last PLEF Study (published in 2018), where a more detailed description for ANTARES and PowrSym can be found.

Both PLEF adequacy tools are built upon a market simulation engine. Such market simulation engine is built upon the assumption of a pure and perfect market.

Simulators solve an optimization problem with an hourly resolution

Both tools calculate the marginal costs as part of the outcome of a system-wide costs minimization problem. Such mathematical problem, also known as “Optimal Unit Commitment and Economic Dispatch” is often formulated as a large-scale Mixed-Integer Linear-Programming (MILP) problem. In other words, the program attempts to find the least-cost solution while respecting all operational constraints (e.g. ramping, minimum up/down time, transfer capacity limits, etc.). In order to avoid infeasible solutions very often the constraints are modelled as “soft” constraints, which means that they could be violated, but at the expense of a high penalty, i.e. high costs. Most mathematical solvers nowadays are capable of solving large-scale Linear Programming Problems (LP problems) with little computation time. However, with the presence of integer variables it is still common in commercial tools to solve the overall problem by applying a combination of heuristics and LP.

In the regional study for PLEF, the size of the problem, i.e. the number of variables and constraints could be huge, i.e. thousands of each of them. The size increases with the optimization time horizon and the resolution. For the PLEF study the optimization horizon is a week and the resolution is hourly, i.e. given the constraints and boundary conditions, the total system costs are minimized for each week on an hourly basis. The latter means that the results such as generation output of the thermal and hydro plants, marginal costs, etc. are given per hour. This setting of the parameters is a common practice for the market simulations which are conducted for the ENTSO-E TYNDP.

Simulators compute NTC and Flow based constraints

For the second time over all PLEF studies the Flow-Based Market Coupling is applied. The necessary Flow-Based domains are considered in the models as additional linear constraints to the optimization problem. The approach follows the same process as used in the ELIA national study and is described in section 3.8.2.

Adequacy assessment relies on probabilistic simulations - Monte Carlo approach

The market simulation tools can be used for adequacy analysis purposes. The two tools used within this study utilise a Monte-Carlo approach, which is considered to be the “state-of-the-art technique” to represent probabilistic variables such as climate data and unplanned outages in electricity market models.

This involves a large number of simulations with random draws (combinations) on the stochastic variables (e.g. climate data, load, hydrological conditions, forced outages, etc.) in order to work out a representative probability distribution curve of the required outputs (e.g. ENS, LOLE). In order to reduce the time required for this big number of simulations, some tools also have a “quick-run” feature which reduces convergence time significantly for each run through the simplification of the optimization problem (e.g. removing integer variables, i.e. the on/off decisions, the ramping constraints, etc.).

3.9.2 Adequacy indicators and relevant model outputs

In generation adequacy analyses, it can be distinguished between deterministic and probabilistic approaches. The system risk, i.e. the probability of a shortage of supply to cover the demand, is subject to the interaction of random factors like unavailability of generation facilities, customer load demand, system behaviour and the fluctuations of feed-in from renewable energy sources (RES). The main disadvantage of deterministic techniques is that they neglect the probability of occurrence, which is why the system risks cannot fully be determined using deterministic criteria. Due to the increased uncertainty introduced by the significant expansion of RES, probabilistic criteria have become increasingly important.

In most of the generation adequacy studies, the Loss of Load Expectation (LOLE also called Loss of Load Duration - LOLD) is used as an indicator amongst others for the measurement of generation adequacy. While this indicator quantifies the expected duration of shortfall, it does not contain any information about the extent in terms of unsupplied energy. Consequently, in this study, a set of criteria as defined in the following is considered. These are often defined on an annual scale and can be measured both at national and regional level.

The LOLE and ENS indicators are the same as the ones measured in the MAF and their definition is taken from the MAF report.

- **Loss Of Load Expectation²² (h/y):**

LOLE is the number of hours in a given period (year) in which the available generation plus import cannot cover the load in an area or region.

$$LOLE = \frac{1}{N} \sum_{j \in S} LLD_j \quad (1)$$

Where, LLD_j is the loss of load duration of the system state j ($j \in S$) associated with the loss of load event of the j^{th} -Monte-Carlo simulation and where N is the number of Monte-Carlo simulations considered. It should be noted *LOLE* can only be reported as an integer of hours because of the hourly resolution of the simulation outputs. *LOLE* does not indicate the severity of the deficiency or the duration of the loss of load within that hour.

The proposed indicator above is quantified by probabilistic modelling of the available flexible resources. Normally there is a tolerated maximum level of the duration of shortfall (e.g. 3 hours in 1 year) defined by each country for the monitoring of security of supply. Accordingly, exceeding this threshold (see Table 2) would mean a violation of the envisaged system security level and corresponding measures would have to be defined and applied. LOLE describes the duration of encountering loss of load but not the severity.

- **Expected Energy Not Supplied or Expected Unserved Energy (EENS) [MWh/y]:**

EENS is the energy not supplied due to the demand exceeding the available generating and import capacity.

$$EENS = \frac{1}{N} \sum_{j \in S} ENS_j \quad (2)$$

Where ENS_j is the energy not supplied of the system state j ($j \in S$) associated with a loss of load event of the j^{th} -Monte-Carlo simulation and where N is the number of Monte-Carlo simulations considered²³.

3.9.3 Monte Carlo scheme - Convergence

To properly assess Security of supply (SoS), both tools simulate a large number of years.

Figure 9 presents the rationale behind the construction of the simulated years. The 35 climate years (1982-2016) from the PECD are combined with random outages based on the specified technical parameters of the types of thermal plants and HVDC links. For the FB approach, wind and load are among the drivers for the shape and the size of the FB domains (small, medium or large). A mapping

²² When reported for a single Monte-Carlo simulation as the sum of all the hourly contributions with ENS, this quantity refers to the number of *hours (events)* within one year for which ENS occurs/is observed and this quantity should be referred to as *Lost of Load Event*. The quantity calculated in Eq. (1) refers to the *average over the whole MC ensemble of Events* and it therefore provides the statistical measure of the expectation of the number hours with ENS over that ensemble.

²³ ENS is often referred in the literature as *Expected Energy Non-Served EENS*. Although we skip the *Expected* from our nomenclature definition, the ENS reported here should be understood as an Expectation or Forecast value and **not** as actual ENS observed in historical statistics of actual power systems behaviour.

of the relevant FB domains is made to be consistent with the climatic condition of each simulated year based on a predefined probability matrix.

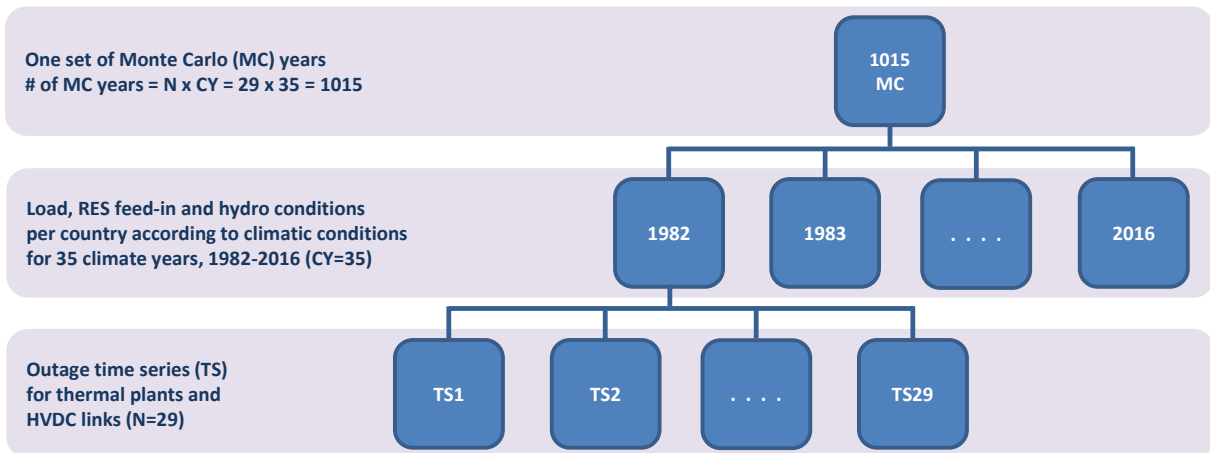

Figure 9: Rationale behind the construction of simulated years, based on an example with 35 climate years and 29 outage scenarios

In such a Monte Carlo approach, it is necessary to carry out a large number of simulations to reach an acceptable convergence of results. Each climate year is assumed to have the same probability of occurrence.

Figure 10 gives an example of the convergence of the adequacy indicator Loss of Load Expectation (LOLE). The graph on the left hand side displays the moving average of LOLE while increasing the number of Monte Carlo years; this value clearly stabilises after a couple of hundred simulations. On the right hand side, the estimated error²⁴ is displayed. After 600 simulated MC years the LOLE can be estimated within a confidence interval of $\pm 1h$.

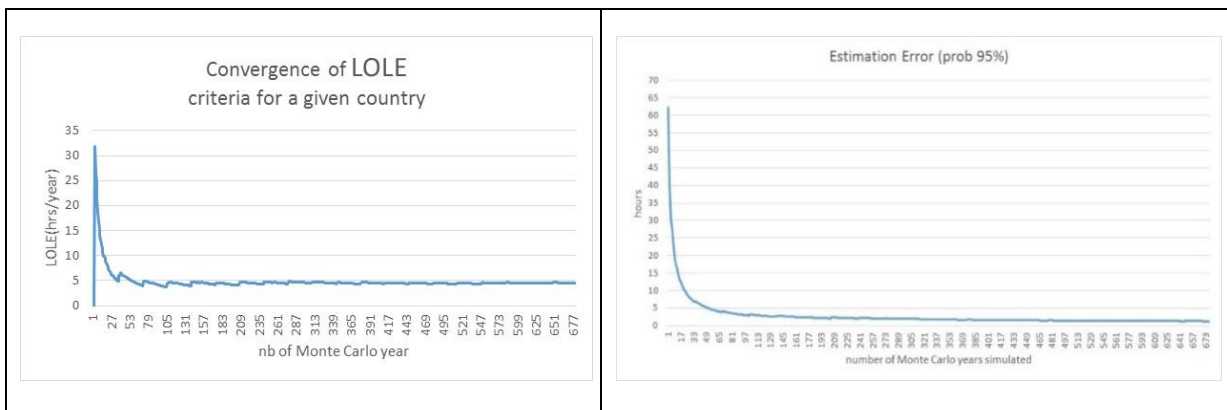

Figure 10: Convergence of the adequacy indicators Loss of Load Expectation (LOLE)

²⁴ The error defined here corresponds to $|\varepsilon_n| \leq 1.96 \frac{\sigma}{\sqrt{n}}$ where n is the number of Monte Carlo years, and σ the standard deviation of the LOLE. The confidence interval for the computed LOLE with N Monte Carlo years (i. e. \bar{X}_N) is given as $\left[\bar{X}_N - 1.96 \frac{\sigma_N}{\sqrt{N}}, \bar{X}_N + 1.96 \frac{\sigma_N}{\sqrt{N}} \right]$

3.9.4 Benefits from using two simulators

For this study two different models (system simulators) were used in parallel. The aim of the use of different models is to produce consolidated, representative and reliable results. The process is shown in Figure 11. The comparison of the results was done for all climatic years according to the following procedure:

- Preparation of aggregated output data of the models
- Visualization of the output data in form of comparison charts
- Discussions and analyses within the PLEF TSO group
- Specification of actions regarding model or data improvement

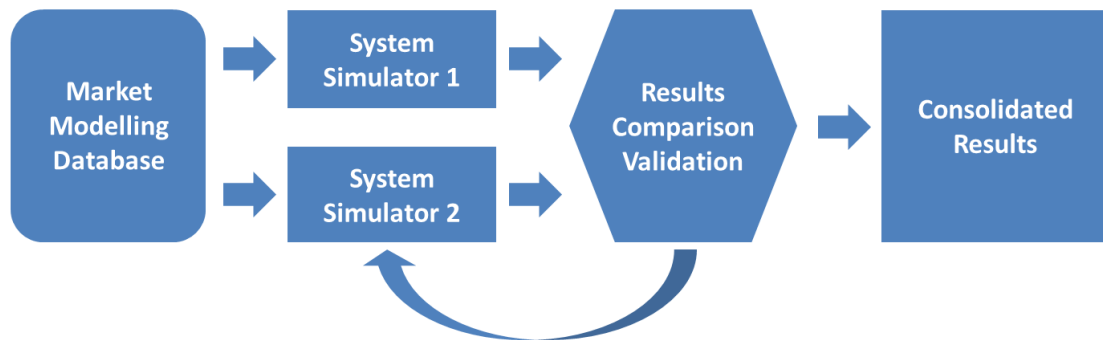

Figure 11 Process of using two simulations in parallel

Although the use of multiple models and the output comparison is a lengthy and time consuming procedure, the following major advantages are connected to it.

Input data quality: Owing to the fact that multiple models are used the input data are checked multiple times independently. This way, errors in the input data will be detected more likely and can be corrected. This leads to a consistent set of input data with high quality.

Synchronization of input data: Some of the input data are also part of the aggregated output data of the models (e.g. PV feed-in, load per country). This way possible input data differences (between the different models) can be detected and corrected. The synchronization of the input data is the basis for the comparison of the actual results and also helps to gain a common understanding of the input data.

Comparison of results: The identification of differences in the results of the models, enables a discussion about e.g. how the models work and how the modelling (e.g. of hydro power plants, biofuel units) is done.

This study has shown a very good convergence of the results computed by both models.

3.9.5 Curtailment sharing

Moreover, in case LOLE is not equal to zero in the CWE region, a so called „adequacy patch“, is active within the generation adequacy simulations. In case of shortage ($ENS > 0$), the goal of this adequacy patch is to achieve a “fair” sharing of the ENS by moving away from the optimal solution at CWE perimeter and towards a solidarity solution regarding ENS redistribution. The „adequacy patch“, is part of the EUPHEMIA Market coupling algorithm (PCR Market Coupling Algorithm) (see Appendix 8.2 for

further details and relevant references), so the principles explained below follow the real market behaviour, expected in (simultaneous) scarcity situations. In EUPHEMIA, shortage and ENS are referred as 'curtailment of Price Taking Orders of Demand'. The final market clearing outcome in scarcity situations will occur after consideration of curtailment sharing, hence after „adequacy patch“.

Without the activation of the adequacy patch the algorithm searches for the global optimal solution (minimization of system costs in the CWE region) which could lead to the fact that under CWE Flow-Based Market Coupling (FBMC) countries with ENS can still export energy to other countries. With the adequacy patch, these countries will reduce their export or might even import and as a consequence reduce the magnitude of ENS. This in turn possibly increases ENS in other countries which rely on imports to ensure their adequacy (and which might or might not have ENS before the application of the adequacy path).

The adequacy patch is applied only when at least one country in CWE has ENS. It redistributes ENS among the contributing countries in CWE in a way that finally only countries, which cannot cover their demand by the local available generation and hence rely on imports to ensure their adequacy, will present ENS.

3.9.6 Sensitivity of the results to the whole set of Monte Carlo years

The fundamental concept of any adequacy assessment relies on their probabilistic nature. Multiple realizations of the power system ('future states' of 'future situations') are simulated. These situations are represented in the Figure 12 below. Most of the situations modelled will still represent average conditions of the power system for which no adequacy concerns are detected.

Still some extreme conditions might (and should) be considered in the whole ensemble of future states modelled. These situations are less frequent, so their probability of occurrence is much lower. Still the impact of these situations might pose a risk to the adequacy of the system. These are the so called 'dimensioning situation' of an adequacy assessment and typically are also referred to as the 'tails of the future states distribution'

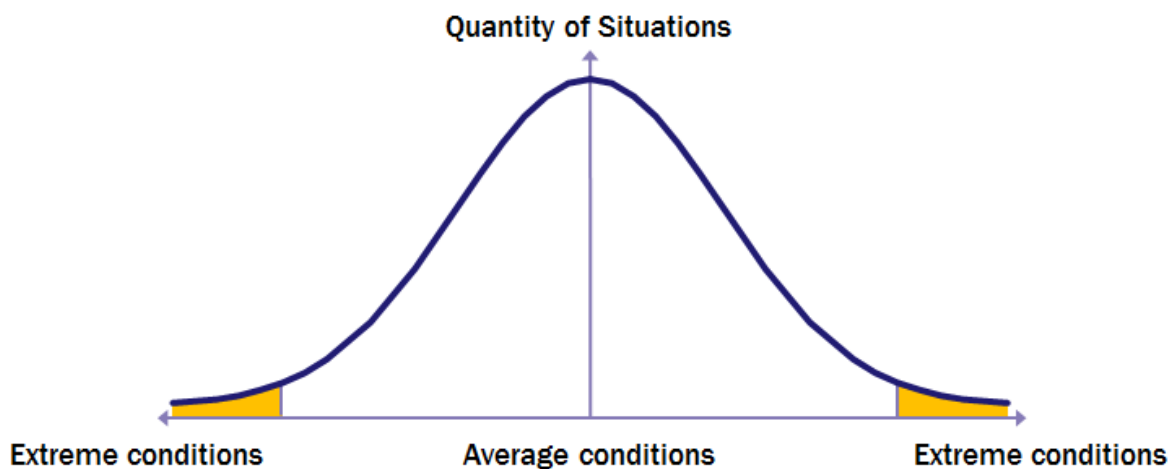

Figure 12: Distribution of Future States

The adequacy indicators reported in the results table (see results chapter), LOLE and ENS, provide the expected level of adequacy 'on average' within the distribution of all 'situations = future states' analysed.

Detailed discussion on the distribution can be found in Chapter 0.

Sensitivity to temperatures

The future states considered in the Monte Carlo approach are constructed by combining climate years and random outages patterns (see Monte Carlo approach in the methodology part).

Figure 13 produced by Meteo France²⁵ shows how severe, from a stand point of temperature, the different climate historical conditions considered in ENTSO-E climate database are.

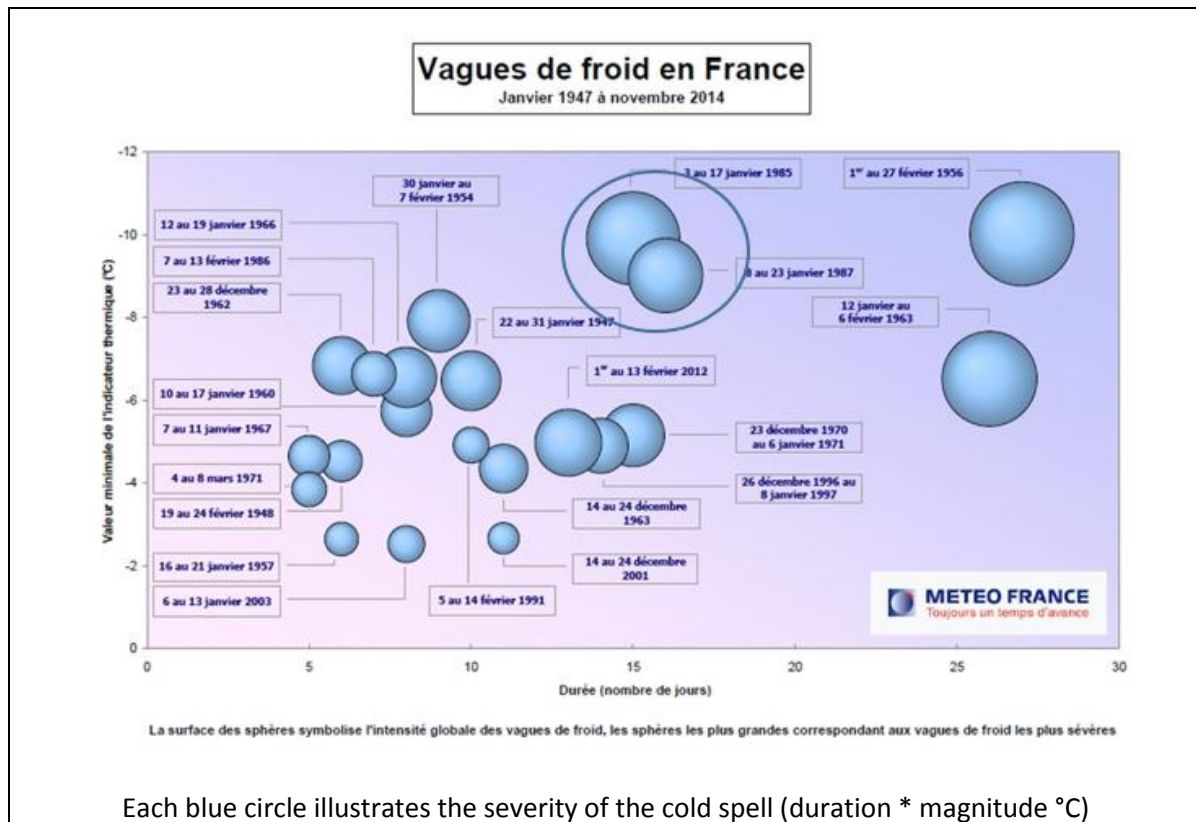

Figure 13: Consideration of cold spell in 1985 and 1987

In 1985 and 1987 a two week-long cold spell hit Western Europe in January with extremely cold temperatures up to 15 degrees below normal conditions as shown in the subsequent graph (Figure 14 also taken from Meteo France). Given the sensitivity of the region to temperature, especially in France (approx. +2.5 GW load/°C), this translates in very stressful episodes for the security of supply. Such situations provide the so-called 'stress test' situations for the region, which are useful to e.g. test its resilience. It should be noted that the probability of occurrence of these extreme situations is expected to be low but still non-negligible.

²⁵ <http://www.meteofrance.fr/prevoir-le-temps/meteo-et-sante/grands-froids#>

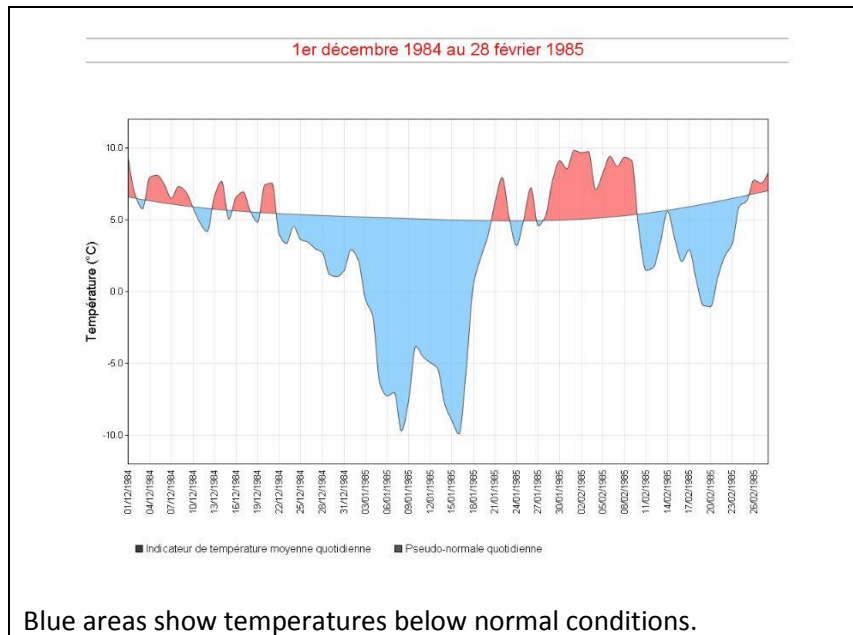

Figure 14: 1985 temperatures in France between December 1st 1984 and February 28th 1985

Considerations of Climate Change

An important question to ask is whether e.g. such ‘week-long cold spell’ as observed in 1985 and 1987, are representative of future situations or rather, allegedly due to global warming, these situations are no longer realistic in the future and hence shall not be considered in adequacy assessments.

These ‘week-long cold spell’ provide extreme yet representative situations which show a realistic stress test situation for the PLEF region, due to their regional impact.

Furthermore, global warming is only a part of the whole global phenomena of climate change. There is no scientific consensus or proof that due to global warming, no cold winters will occur in Western Europe or that such ‘week-long cold spells’ will never occur again.

A global increase of the temperature of the Earth due to ‘global warming’ might actually cause a slowing down of the ‘Gulf Stream’ mechanism which makes the winters in Northern Europe milder than eg. in the East Coast of USA and Canada:

‘...Consensus has emerged that climate change will lead to a slower Gulf Stream system in the future, as melting ice sheets in Greenland disrupt the system with discharges of cold fresh water. A weaker Gulf Stream would mean higher sea levels for Florida's east coast. It could lead to colder winters in northern Europe (one reason many scientists prefer the term climate change to global warming)’²⁶

ENTSO-E and TSO acknowledge the importance of an evolution of the current ENTSO-E climate database in order to properly capture the complex behaviour of climate change in MonteCarlo simulations for adequacy. This is within the scope of the evolution of the MAF methodology towards ERAA.

²⁶ “The Gulf Stream is slowing down. That could mean rising seas and a hotter Florida” <https://phys.org/news/2019-08-gulf-stream-seas-hotter-florida.html>

Still up to date the best database available at ENTSO-E is the one relying on 1982-2016 historical years. It is considered that this database includes realistic yet extreme climate situations, which allow to construct a meaningful distribution of future states to perform robust adequacy studies.

What is Climate?

'Climate in a narrow sense is usually defined as the "average weather," or more rigorously, as the statistical description in terms of the mean and variability of relevant quantities over a period of time ranging from months to thousands or millions of years. The classical period is 30 years, as defined by the World Meteorological Organization (WMO)'²⁷

Climate seasonal 'normals' need to be calculated based on a minimum 30 years, after recommendation from the World Meteorological Organization (WMO)²⁸:

*While 30 years is still recommended as a standard averaging period for the calculation of quintile boundaries in climatological standard normals (and thus as the basis for the reporting of quintile values in CLIMAT messages), the stability of more-extreme statistics derived from that period is likely to be low for some elements. [...] Two approaches to that problem are to fit a statistical distribution, such as a gamma distribution, to the observed data within a standard 30-year period (an approach discussed in more detail in *The Role of Climatological Normals in a Changing Climate* (WMO, 2007)) or to use a period of data substantially longer than 30 years. Another application where the longest possible record is of interest is in the reporting of extreme values.*

Also NASA mentions²⁹ :

Some scientists define climate as the average weather for a particular region and time period, usually taken over 30-years. It's really an average pattern of weather for a particular region.

The current ENTSO-E database composed of 35 historical years does meet the requirements from the World Meteorological Organization (WMO) and NASA for a representative climate database. Furthermore the fact that it is larger than just 30 years follows the recommendation of usage of '*the longest possible record [...if the...] interest is in the reporting of extreme values*', which is indeed the case for adequacy assessments.

²⁷ World Meteorological Organization http://www.wmo.int/pages/prog/wcp/ccl/faq/faq_doc_en.html

²⁸ World Meteorological Organization https://library.wmo.int/doc_num.php?explnum_id=4166

²⁹ "What's the Difference Between Weather and Climate" https://www.nasa.gov/mission_pages/noaa-n/climate/climate_weather.html

4. Input data, assumptions and country specifics

The template for data collection and thus the perimeter of the input data of the PLEF study is based on the MAF 2019 process. The data of the PLEF region were gathered from its countries for the relevant time horizons. The final data was frozen end 2019.

For all other countries the MAF 2019 data of the “National Trends” (NT) scenario for the time horizon 2025 was used. Please find some more details about the country specifics in the following paragraphs.

4.1 Austria

The installed operational capacities for Austria quoted in the Figure 15 are based on the values published by E-Control (Austria’s NRA) and the development plan published by “Oesterreichs Energie” and represent the values for the base case scenario.

In Austria generation capacity was contracted as grid reserve for redispatch measures in case of critical network congestions until 2021. Since no contracts are available until 2025, in the current PLEF study we follow an optimistic approach, so the originally contracted plants for 2025 are assumed to be still available.

The assignment of the installed operational capacities of the Austrian (pumped) storage power plants within the “Kraftwerksgruppe Obere Ill-Lünersee” (capacity: approx. 2.2 GW) as well as the power plant „Kühtai/Silz“ (790 MW) has been moved to the German control block. Although these power plants are all located in Austria, they are directly connected to the German control block.

Within all relevant time horizons, all new power plant projects have been considered as long as grid access was officially applied to. The increase of wind and solar power capacities was calculated based on assumptions regarding the #mission2030, which was the official document published by the Austrian government in June 2018 indicating the goals for renewable development.

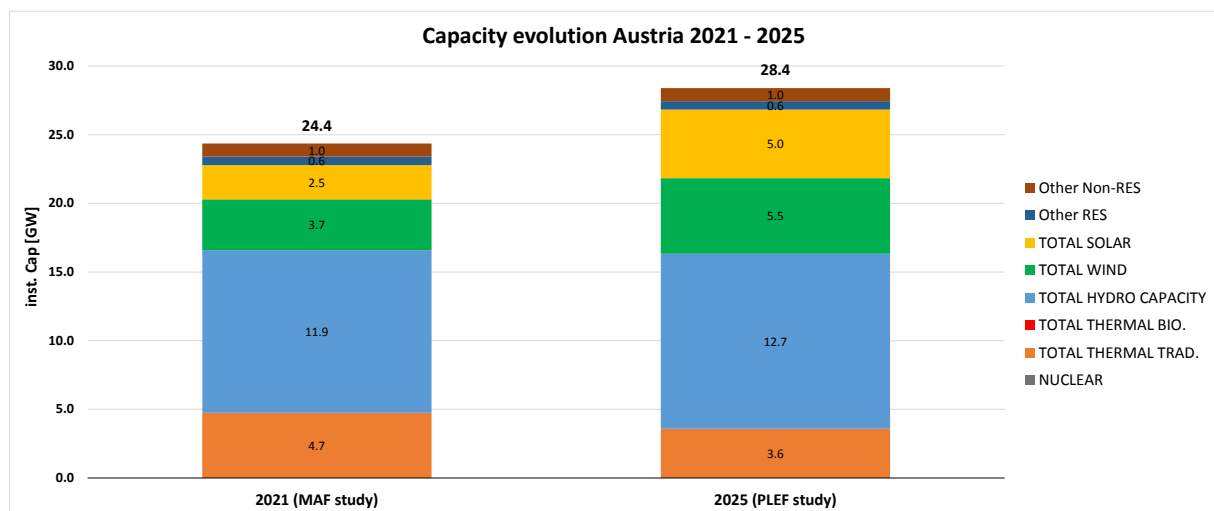

Figure 15 Generation mix (operational capacities) of Austria base case 2021 and 2025

The demand time series used in the study also consider the extra load of additional electric vehicles, heat pumps, hybrid heat pumps and other additional loads together with an annual average increase of the load.

The NTC values were taken from the MAF 2019. For the first time the border between Germany and Austria is connected to the CWE region using a flow based approach in adequacy studies.

Hydro modelling

Regarding the aggregation of run of river and swell production as described in the hydro section of this report, it is worth to mention that such an aggregation has a considerable impact on the modelling of the Austrian hydro dispatch capabilities, since swell fluvial power plants sum up to 1.3 GW of installed capacity and 22 GWh reservoir capacity expected for 2025. Investigations were initiated by APG concerning how to best implement this type of storage potential into mid to long term adequacy modelling, complying with the new hydro database format and guidelines. This new approach, providing a distinct representation of pure run of river and swell power plants was not implemented in the current PLEF study, whereas it will be applied for the first time in the upcoming MAF 2020 study.

Low Gas Sensitivity

For the Low Gas Sensitivity Austria removed a total capacity of 1164 MW, which is due to end of operating life expectancy and economic reasons (no CHP).

4.2 Belgium

Elia is committed to ensuring a high level of consistency between national, regional and Pan-EU adequacy assessments relevant for Belgium, by developing and applying a common probabilistic methodology and ensuring complementarity of the results obtained between the different studies.

The latest 'Adequacy and flexibility study for Belgium 2020-2030' was published by Elia in June 2019 (Elia study 2019, see footnote 3). This study analysed the level of adequacy for the coming 10 years, which includes the impact that the planned Belgian nuclear phase-out will have on adequacy. As from 2025, once the nuclear phase-out is completed, the study identified a structural need for new capacity of up to 3.9 GW. This need includes about 1.5 GW of capacity to cover for uncertainties which are beyond Belgium's control.

Assumptions used in MAF / PLEF are in-line with national reports (for the corresponding time horizons)

For the 2021 and 2025 time horizons tackled in the MAF/PLEF, the assumptions for Belgium are in line with the recent 2019 study [AdFlex19]. Those consider all existing gas units for both time horizons. RES assumptions are based on the 'National Energy and Climate Plan' submitted by Belgium end of December 2018. The DSR and storage capacities are based on the 'Belgian Energy Pact' assumptions agreed upon by different Belgian authorities in 2018. For 2025 no nuclear capacity is assumed in Belgium, in accordance with the planned nuclear phase-out. The data for Belgium has been slightly updated with respect to the MAF2019 data based on latest available information known end of 2020. Updates relate to: i) -0.1GW which considers the decommissioning of biomass capacity; ii) +0.4GW which considers the return to the market of some gas capacity.

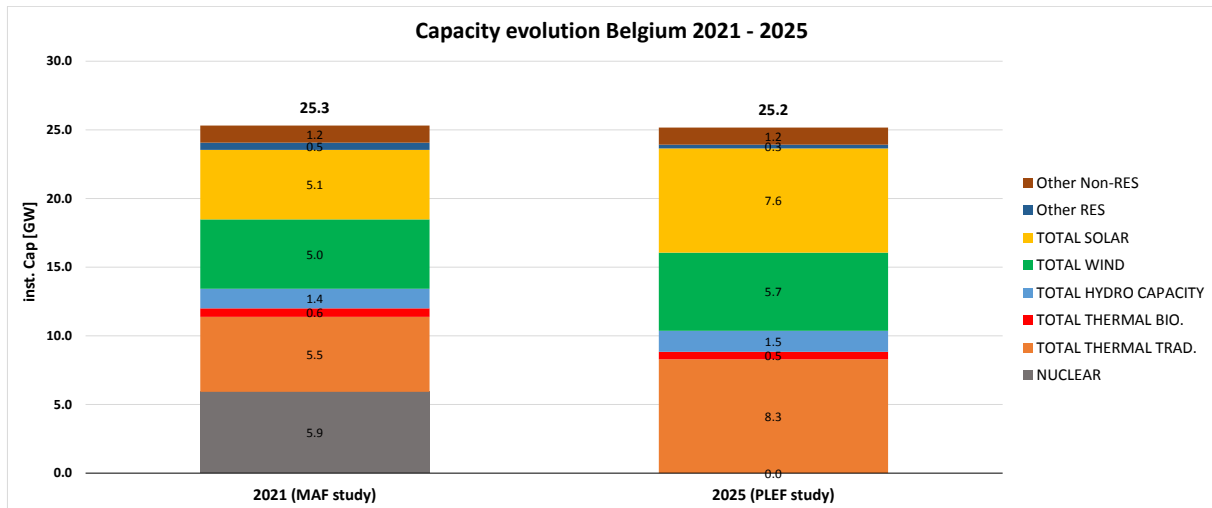

Figure 16 Generation mix (operational capacities) of Belgium base case 18/19 and 23/24

Low Gas Sensitivity

In the 'Adequacy and flexibility study for Belgium 2020 – 2030' report (Elia study 2019, see footnote 3) a minimum volume (assumed 100% available) of 'new built' capacity of 2.4 GW is identified in the BaseCase ('EU-BASE'). Furthermore, it should be noted that this volume increases to 3.9GW to cover for uncertainties which are beyond Belgium's control.

For the 'Low Gas Sensitivity' in PLEF for Belgium, the assumed new capacity of 2.5 GW was removed from the PLEF 'Base Case', following the storyline of this sensitivity agreed within the PLEF SG2 group:

"Power plants might be mothballed or decommissioned due to low number of full load hours and in turn low profitability. Such economic conditions might also prevent new investments in Gas units also".

It should be noted that no economic viability checks have been performed in PLEF. The volume 'at risk' of 2.5GW considered in PLEF (which consist of the new capacity assumed for Belgium-, would therefore increase to about 4 GW should the 'already existing capacity in Belgium but needing refurbishment' be considered also at risk in the 'Low Gas Sensitivity'. This 'already existing capacity but needing refurbishment' capacity is assumed as existing in 2025 in Belgium throughout all PLEF scenarios (Base Case and Sensitivities) considered, although there no guarantee this capacity would remain in the market without a market – wide CM in Belgium. It has been checked that, should a value of around 4 GW had been considered at risk in the 'Low Gas' sensitivity for BE instead of 2.5GW, then the reported value of LOLE ~8.1h (see Chapter 6 of results) would have increased to LOLE ≥10h which is consistent with the results of the Elia study 2019, (see footnote 3).

4.3 France

The National Energy and Climate Plan (NECP)

Since 2015, a new legal framework known as “loi de transition énergétique pour la croissance verte” with its planification documents “stratégie nationale bas-carbone” and “programmation pluriannuelle de l’énergie” has been established to provide a roadmap for the energy field in the next years.

In early 2019 the National Energy and Climate Plan, elaborated in these two documents, has been officially updated through a draft version.

Load and annual demand forecast provided for 2021 and 2025

Over the past several years, RTE has observed a stabilization of electricity demand in France, mainly due to a moderate economic growth and energy efficiency measures, in compliance with the ambitions of the French NECP. These efficiency measures will be further developed in the coming years, so that the electricity demand is likely to remain stable in spite of sustained demographic growth, a recovery in economic activity and a development of the electricity uses (transport, hydrogen, heating...) with reduced CO2 emissions.

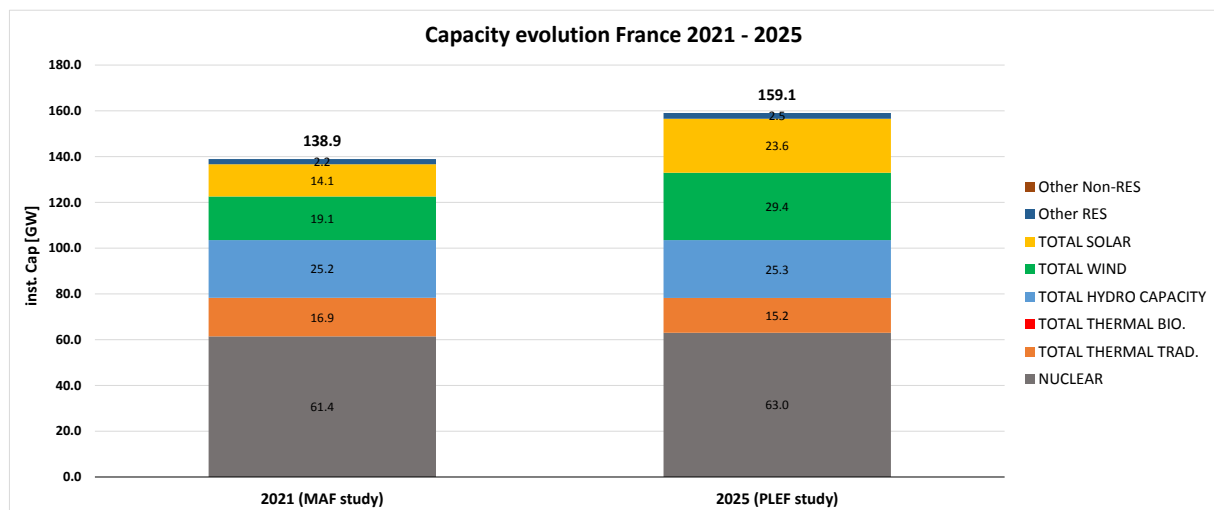

Figure 17 Generation mix (operational capacities) of France base case 18/19 and 23/24

Net generating capacity forecast provided for 2021 and 2025

The targets of the French NECP are reached within the central scenario of the MAF and the PLEF GAA. The paramount evolutions for the French energy mix are :

- Accelerated development of RES (wind and solar capacities are multiplied by more than three in the next ten years);
- Coal phase-out complete by the end of 2022³⁰ ;

³⁰ In January 2020, the French Ministry for the Ecological and Inclusive Transition has announced that the decommissioning of the Cordemais power plant could be postponed to 2024 or 2026 if necessary, in order to ensure the security of electricity supply. The plant would be operated 90% less frequently than today and could be partially converted to biomass. This assumption has not been taken into account in the PLEF GAA, as the announcement has been made after the data collection.

- No commissioning of new gas units, except CCGT Landivisiau in 2021;
- Two nuclear units in Fessenheim will be shut down in mid-2020;
Commissioning of the new Flamanville power plant in 2023³¹;
- Decrease of the nuclear power fleet forecasted after 2025 in order to reduce the nuclear share in electricity production to 50% by 2035.

Low gas sensitivity

In the last national adequacy study published in 2019³², RTE studied a sensitivity that considered a downward trajectory of the gas combined heat and power (CHP) plants³³. As announced in the French NECP, existing purchase obligation contracts will be neither extended nor renewed for CHP plants. Their revenues will then depend only on the electricity market and the capacity mechanism. Small decentralized gas units³⁴ were also subject to a decreasing trajectory in a sensitivity. To assess the impact of the uncertainties of their future economic viability, the French adequacy report thus studied a decrease of the total capacity for these types of production, as approved in a public consultation where French market stakeholders participate to share their visions for the study. Based on this scenario, 2225 MW of gas units have been removed between the base case of the PLEF GAA 3.0 and the low gas sensitivity.

Low nuclear sensitivity

In the last two national adequacy studies, RTE has highlighted that the availability of the nuclear reactors is a key factor in terms of security of supply, especially as the programme to extend the lifespan of reactors beyond 40 years is just about to start. Around forty reactors are due to undergo ten-year inspections during the period 2020-2025. For more than half of them this will be their "fourth ten-year inspection" (for reactors of 900 MW). As these inspections are the first ones of their type and the Nuclear Safety Authority has not yet published any generic opinion on the subject, this issue requires close monitoring in the analyses of this adequacy report.

To take account of these issues, the analyses in the French adequacy report are based on refined availability assumptions for the winter, according to the ten-year inspections schedule declared by the producer. This modelling is used to assess the specific situation of each of the coming winters according to the reactor outages already scheduled, and the consequences of any extensions of these stoppages beyond the projected timescales.

Since 2018, the French report has thus studied the impact of different extensions of initial schedule of the ten-year inspections up to three additional months, which is close to what has been observed in the last few years (two months in average).

Although the approach modelled in the last French reports (basing the availability on the maintenance schedule declared by the producer) is not used in the PLEF GAA 3.0 (which has used instead a probabilistic approach to set up the maintenance schedule), the assumption for the low nuclear sen-

³¹ Due to technical issues, the producer EDF has announced that the power plant will not be commissioned before the end of 2022. The assumption for the PLEF GAA is thus based on a commissioning in 2023.

³² https://www.rte-france.com/sites/default/files/bp2019_rapport_complet_1.pdf

³³ At the end of 2018, the total installed capacity of gas CHP plants was 5 GW.

³⁴ At the end of 2018, the total installed capacity of small decentralized gas units was 5 GW.

sitivity has been defined, in a way, according to this method. In this sensitivity, 1700 MW of nuclear capacities have been considered as additional unavailabilities. This assumption was indeed the average³⁵ difference of capacity margins³⁶ estimated in the last French adequacy report between (i) a scenario with strict compliance of the initial ten-year inspection schedule and (ii) a schedule extended by three months (see the extract, Figure 18, below).

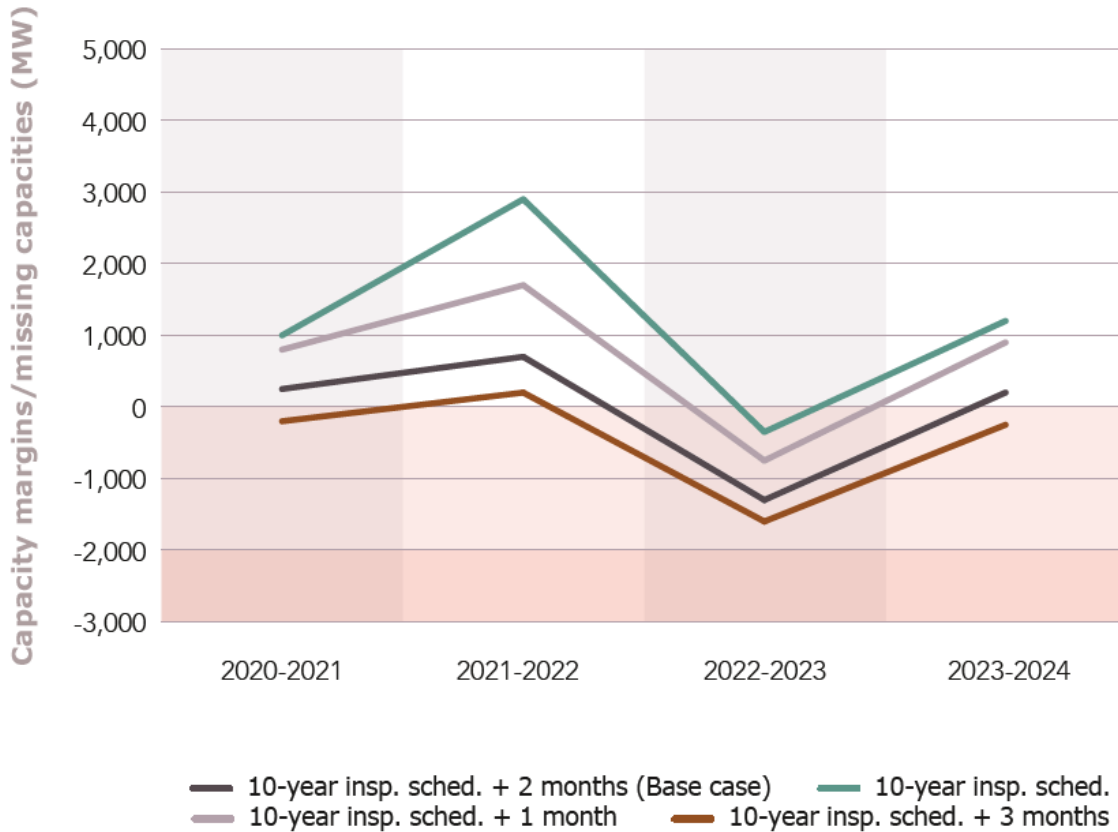

Figure 18 Margins in the base case and in other scenarios of ten-yearly inspections

4.4 Germany

The assumed thermal capacities for Germany correspond to the expected development at the time of the data collection. The latest information about mothballing, decommissioning as well as the commissioning of new power plants is considered. The development and the foreseen schedule for the phase out of nuclear power plants are also reflected in the data collection. Especially the phase-out of nuclear and coal capacities in combination with the provision of capacity and security reserve lead to a strong decrease of the overall thermal capacity by 2023/24.

RES development corresponds to the political targets. It is assumed that the installed PV-capacity as well as the installed wind-capacity will increase from 2021 to 2025. For Run-of-River (RoR) power

³⁵ The difference of capacity margins is depending on the considered winter, hence the arbitrary assumption of average in the medium term.

³⁶ In the French report, capacity margins are defined as the capacity that the power system has in addition to what corresponds to level of SoS strictly compliant with the national reliability standard.

plants the installed capacity remains constant. Table 6 gives an overview of the installed RES capacities used for the MAF (2021) and the PLEF (2025) for Germany.

	2021	2025
PV	55 GW	73 GW
Wind-Onshore	61 GW	71 GW
Wind-Offshore	7.9 GW	10.5 GW
RoR	4 GW	4 GW
Other RES	8.5 GW	7.9 GW

Table 6 RES capacities in Germany

The installed capacity of Hydro-Pumped-Storage-Power-Plants increases by 2 GW over the analysed time horizons.

A detailed description of the different reserves in Germany can be found in chapter 3.7.4. The corresponding values are shown in Table 7.

	2021	2025
Capacity reserve	1 GW	2 GW
Grid reserve	6.8 GW	6.8 GW ³⁷
Security reserve	Ca.2 GW	0 GW

Table 7 Assumed reserves in Germany

As the Security and the Grid reserves are not participating in the electricity market the total power plant capacity in Germany was reduced accordingly. A Capacity Reserve of 1 GW was contracted by the German TSO in 2020 after the data collection for this study was completed. Due to this uncertainty at the point in time of the data collection process, a small share of this capacity is included in the Base Case data, although also the Capacity Reserve is not participating in the electricity market.

Furthermore, a capacity of one GW of “Switchable Loads” is assumed for 2025. As these capacities are operated by the German TSO, they also do not participate in the electricity market.

The impact of the Capacity Reserve and Switchable Loads on the results for 2025 is considered in an ex-post analysis for Germany. The results of this analysis are presented in section 6.5.

Flexibilities of 1.5 GW, which are reacting to price signals coming from the energy market are modelled in the adequacy tools directly.

It is assumed that the overall yearly demand will decrease from 2021 to 2025 due to trends in increasing energy efficiency according to political targets. This effect is diminished by an increased consumption of electric vehicles (EV) and heat pumps (HP).

³⁷ The exact amount of the grid reserve for 2025 was not confirmed at the point in time of the data collection. Therefore, it was assumed to stay constant for both time horizons.

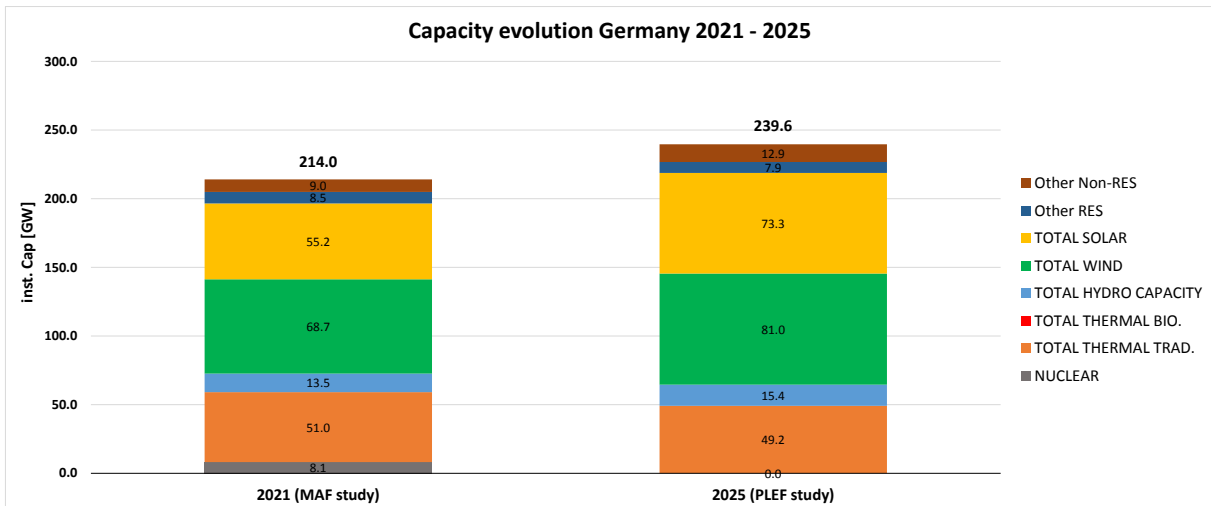

Figure 19 Generation mix (operational capacities) of Germany base case 2021 and 2025

4.5 Luxembourg

The assumptions used for the load and capacity forecast for Luxembourg in the present PLEF report are in line with the MAF 2019/TYNDP 2020 based on NECP.

Load and annual demand forecast

The demand forecast provided until 2025 assumes a stable load and demand increase due to a steady increase of the population from currently 614,000 inhabitants (1.1.2019) to 690,000 inhabitants in 2025. First benefits related to energy efficiency measures can be noticed and should affect positively the further load increase due to new housing development and building renovations. Nevertheless a trend to use more electricity for heating (heat pumps) and mobility (electric vehicles and electric buses) can be observed.

A load increase is also considered to account for the additional demand of contracted IT data-centers or new IT data-centers to be built in the coming years. The forecast reflects the situation at the time of the data collection.

For both time horizons no additional DSF capacities are considered.

Net generating capacity forecast

It is assumed that the installed PV-capacity as well as the installed wind-capacity will increase according the national RES targets defined in the NECP until 2030. All other installed capacity is supposed to remain constant. The thermal capacity based on decentralized gas fired cogeneration units will probably be decommissioned by 2025 in case the support mechanism will cease. This capacity decrease has been considered in the gas sensitivity assessment.

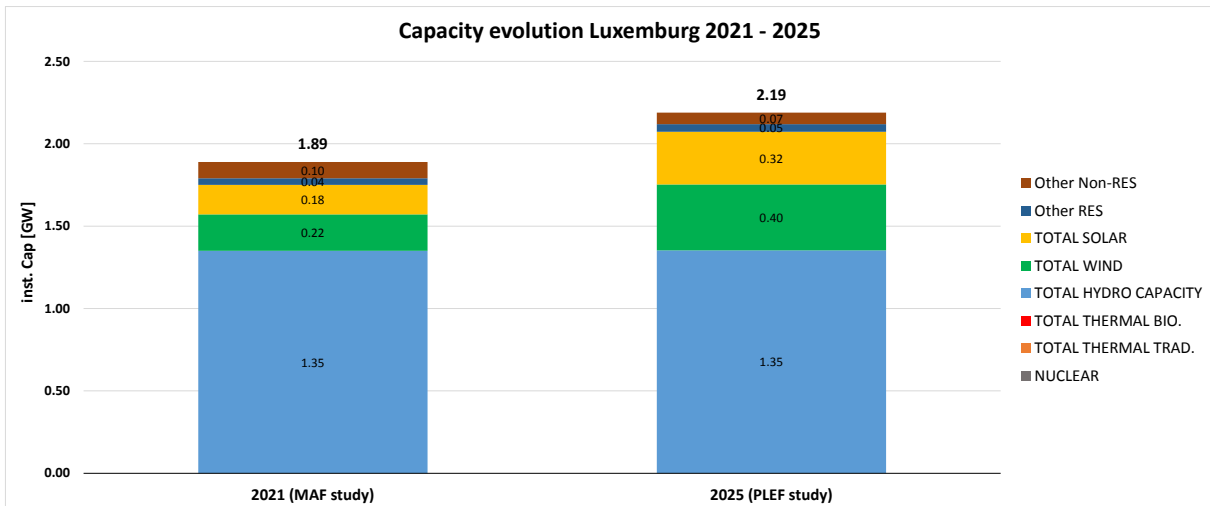

Figure 20 Generation mix (operational capacities) of Luxemburg base case 2021 and 2025

Low Gas Sensitivity

For the Low Gas Sensitivity for Luxemburg, the ‘identified new built’ capacity of 0.1 GW was removed, following the storyline of this sensitivity agreed within the PLEF SG2 group. Small decentralized gas units were also subject to a decreasing trajectory in sensitivity. Their revenues will then depend on the support scheme.

4.6 Switzerland

The data for the generation scenarios in Switzerland are based on the Swiss Energy Strategy 2050. The generation from renewable sources increases as estimated except for wind production where recent observations show a slower increase than assumed by the strategy. For electricity production based on nuclear fuel, an operating time of 50 years is assumed.

The increase in hydro production is assumed to be moderate since most of the planned units are already built and in operation.

The probabilistic hourly load data as well as the weekly hydro energy data are taken from the MAF database while the NTC values are provided by Swissgrid network planning experts according to the projected commission of different reinforcement projects. The load and hydro data provided by Swissgrid are based on the assumptions given and published in MAF. The data provided by Swissgrid for the MAF were not derived using the reanalysis methodology described in section Hydro. Instead, historic data for reservoir levels and production were provided by the SFOE and inflows were derived using these data. Where historic data were not available (for the years 1982 until 1990), the correlation of river flow data to available years was used and the data of these available years were used.

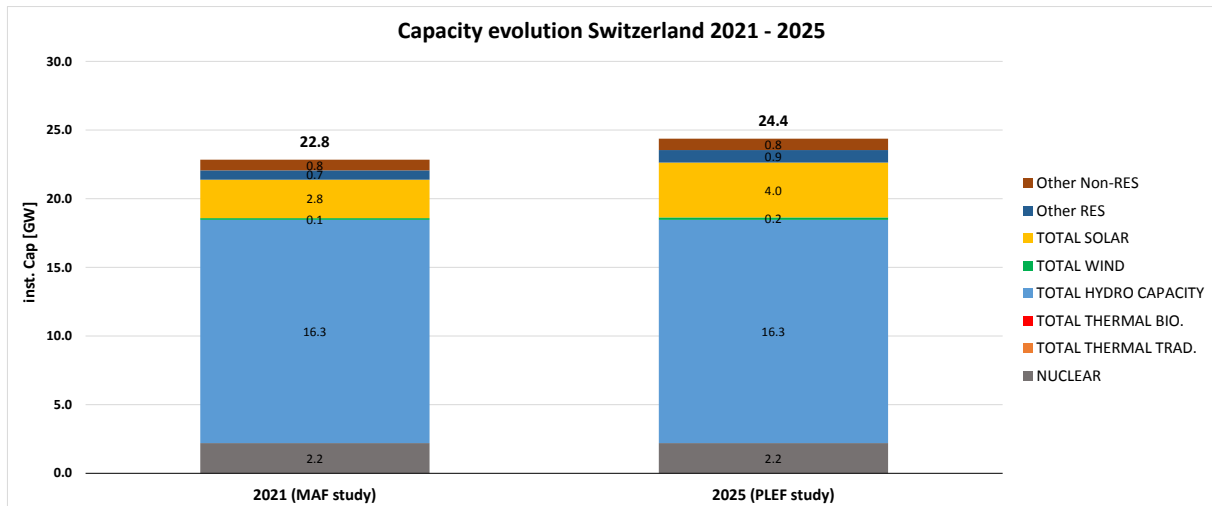

Figure 21 Generation mix (operational capacities) of Switzerland for 2021 and 2025

For the Low Nuclear / CH NTC sensitivity, NTCs between Switzerland and the neighbouring zones are reduced in order to take into account increasing unscheduled flows through Switzerland.

In 2025, CORE countries will have to comply with the 70% minRAM rule stipulated by the CEP. This rule has the potential to increase cross-border flows substantially. If Swiss network elements and their constraints are not taken into account properly in the FBMC market clearing algorithm, this could lead to a significant increase of unscheduled flows over Swiss network elements.

Switzerland is currently not participating in the flow-based market coupling, and at the time of writing it is not clear if it will be participating in 2025 or if Swiss network elements will be included properly in the computation of cross-border exchange capacities within CORE. In case neither of both will materialize, the general reduction of NTCs may be necessary, instead of continuous preventive and/or curative remedial actions.

The reduction of NTCs with Switzerland's neighbours is the same as it was assumed in the adequacy study performed for the Swiss National Regulatory Authority (ElCom³⁸). The values are shown together with the values used in the MAF 2019 in Table 8.

Area	Import CH		Export CH	
	PLEF 2025 [MW]	MAF 2025 [MW]	PLEF 2025 [MW]	MAF 2025 [MW]
AT → CH	800	1200	800	1200
DE → CH	1700	2700	2700	4600
FR → CH	2500	3700	1000	1300
IT → CH	1650	1700	2000	3750

Table 8: Reduced NTCs between Switzerland and its neighbours for the Low Nuclear / CH NTC sensitivity.

³⁸ <https://www.elcom.admin.ch/dam/elcom/de/dokumente/2018/Schlussbericht%20System%20Adequacy%202025.pdf.download.pdf/Schlussbericht%20System%20Adequacy%202025.pdf>

4.7 The Netherlands

Besides the regional PLEF adequacy study, TenneT carries out national adequacy studies on annual base as a statutory duty to inform Minister of Economic Affairs of the Netherlands. Main goal of the national report is to provide insight into expected short and midterm development of the adequacy in the Netherlands and, if necessary, advice the Minister on measures to safeguard the security of supply. In addition, the report aims to inform the market.

The overall methodological approach of the national and this regional PLEF study are in line with each other. The supply and demand data for the PLEF study are based on current information available during the period of data gathering.

Alignment of assumptions in MAF, PLEF and national studies

Because of different time slots for data gathering for national, PLEF and MAF studies the input data is not 100% aligned. The most recent Dutch national adequacy study³⁹, published in January 2020, has a more recent dataset as compared to MAF 2019 study for time horizon 2021 and this PLEF 3.0 study for time horizon 2025.

The total electricity demand assumed in the PLEF and MAF studies (around 115 TWh for both study horizons) is slightly lower as compared to the most recent assumption used in the national study with a demand assumption of around 118 TWh.

On the supply side the data assumptions for the 2025 horizon, analysed in this PLEF study, is fully in line with the latest Dutch national adequacy study. For time horizon 2021, due to a change in mothballing schedules of some gas fired power plants, the overall installed operational thermal capacity is approximately 0.5 GW higher in the most recent national study as compared to the MAF study.

The above mentioned differences do, however, not have a big impact on the results or the conclusion of this PLEF study.

Supply developments for thermal power plants and RES

In the past years, market conditions for gas-fired power plants have improved in the Netherlands and market parties brought back some mothballed power plants into operation. In addition, a total of 1.3 GW gas-fired capacity will be de-mothballed and brought back to the market this year (2020). Also a number of future shutdowns will be postponed several years.

The overall picture in the period 2021-2025, however, shows a decrease of operational thermal production capacity in the Netherlands, due to several plans to proceed with de-commissioning and mothballing of thermal production capacity.

³⁹ Rapport Monitoring Leveringszekerheid 2019:
https://www.tennet.eu/fileadmin/user_upload/Company/Publications/Technical_Publications/Dutch/20200117_Rapport_Monitoring_Leveringszekerheid_2019.pdf

The starting points for the development of renewable energy are mainly based on the Dutch Climate Agreement⁴⁰ and the design calculation of the draft climate agreement⁴¹. As of January 1st, 2025, a total installed wind capacity of 10.9 GW (5.7 GW on-shore; 5.2 GW off-shore) and a solar-PV capacity of 10.9 GW is assumed. The assumed RES capacities ultimo 2030 will be: 11.3 GW wind off-shore, 7.8 GW wind on-shore and 25.0 GW solar PV.

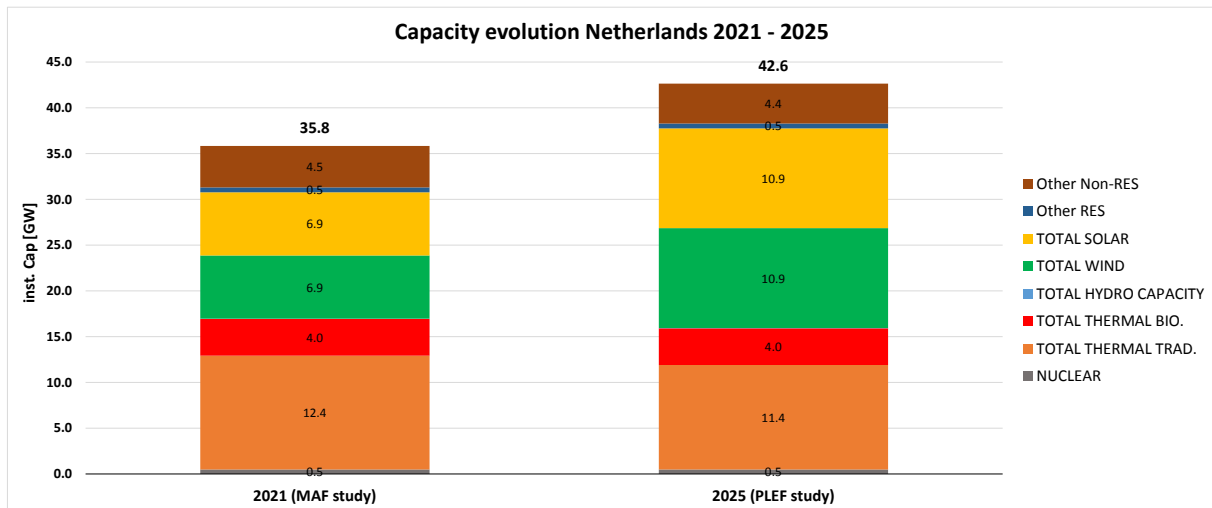

Figure 22 Generation mix (operational capacities) of The Netherlands base case 18/19 and 23/24

DSR

The further development of Demand Side Response (DSR) can be seen as one of the contributions to future security of supply. TenneT is working on further improving the DSR modelling in its adequacy analyses. As a first step in 2019, TenneT carried out a study to obtain the best possible picture of the DSR currently active in the market. The study was based on the hourly EPEX supply and demand bids of the past years and has resulted in a first conservative estimate of a 0.7 GW DSR potential available for adequacy purposes. This estimate has been used in both the national study and the PLEF study. In the years to come TenneT intends to further improve the DSR modelling and use these improvements in upcoming editions of the national adequacy studies.

Low Gas Sensitivity

For the Low Gas Sensitivity for the Netherlands, a total capacity of 1.6 GW was removed. Power plants might be mothballed or decommissioned due to low number of full load hours and in turn low profitability. This is in line with the assumptions for a similar sensitivity in the last Dutch national adequacy study.

⁴⁰ Klimaatakkoord (Rijksoverheid, juni 2019) (Dutch climate agreement)

<https://www.rijksoverheid.nl/onderwerpen/klimaatakkoord/documenten/rapporten/2019/06/28/klimaatakkoord>

⁴¹ Achtergronddocument Effecten Ontwerp Klimaatakkoord: elektriciteit (PBL, april 2019)

https://www.pbl.nl/sites/default/files/downloads/pbl-2019-achtergrondrapport-effecten-ontwerp-klimaatakkoord-elektriciteit_3685.pdf

5. Study framework

In order to give a clear picture of the expectations on this adequacy study it should be stated that this study will model the electric power system using predefined situations described in the base case scenario and in two different sensitivities. The commissioning and de-commissioning of generation capacities are given exogenously for each of these three scenarios. The scenario framework was discussed and agreed between the TSOs and the ministries of the PLEF region. This adequacy assessment will model how the production resulting from the given installed capacities will meet the forecasted demand but should not lead to statements on whether or not the market works properly or investments will be made in the assumed way in the near future. This stems especially from the fact that a central optimized dispatch is simulated – not a bottom up market – and the available generation capacity is given exogenously. The above mentioned assumption and methodological choices follow the current ENTSO-E methodology regarding probabilistic adequacy assessments. Targeted market modelling exercises are more suitable to derive information such as optimal installed capacity of generation facilities.

PLEF time horizons

Since the way of gathering input data in the MAF process drastically changed during the last 2 years, also in PLEF the new way of modelling the new input data format, was applied. Not only the change of input data format, but also the implementation of the new flow based modelling approach described in chapter 3.8.2 led to an increase of workload for modelling teams. Therefore, it was decided to only perform the assessments on the 2025 time horizon. This mid-term horizon was chosen together with the ministries as the main PLEF time horizon. In order to also have some reference to short term results, the MAF 2021 results are placed in this report as some type of reference.

As the base case for each of the time horizons is utilizing the most recent information available at the TSOs regarding e.g. the commissioning, decommissioning and mothballing of power plants, changes or drivers for changes in the power system are addressed in the different sensitivities. Amongst others this could be additional flexibilities acting on the energy market or new capacity regimes leading to changes of the installed capacity of the base case compared to the MAF data. Also other effects like e.g. additional outages are covered.

The treatment of the different system adequacy mechanisms is described in chapter 3.7.

5.1 Base case

In order to build the base case model for 2025, the input dataset from MAF 2019 was taken and adapted by the updates provided by PLEF TSOs.

Since the flow based model for the CWE region had to be set up from the beginning for the 2025 time horizon, the following additional requests from PLEF ministries were incorporated by the TSOs:

- 70% CEP capacities for the PLEF region
- Flow based model including the DE/AT split
- CWE region only (no CORE region)

5.2 Sensitivities

Sensitivity 1 – Low Gas

Since high penetration of renewables and moments of high renewable in-feed to the European electricity grid can lead to low price levels on the energy market, the commercial viability of thermal power plants, especially of those with high marginal prices is significantly impacted.

Consequently, power plants might be mothballed or decommissioned due to a low number of full load hours and in turn low profitability. Furthermore, such economic conditions might prevent new investments in gas units also.

For this study, a total thermal capacity of 7.6 GW at risk was identified for the whole PLEF region and removed for the calculation in order to create sensitivity 1.

 PLEF Low Gas	
Area	Reduced Gas Capacities [GW]
AT	-1,2
BE	-2,5
CH	-
DE	-
FR	-2,2
LU	-0,1
NL	-1,6

Table 9 Low Gas sensitivity assumptions

Sensitivity 2 –Low nuclear / Low NTC Switzerland

This sensitivity was created based on the historic experience of the winter 2016/2017.

At the time the situation became tense from system operations perspective due to a combination of the following events:

- Lower nuclear availability than expected in France and Switzerland due to unplanned outages
- Compensation of the additional unplanned outages by higher Swiss hydro production in January, contributing to emptying the Swiss hydro reservoirs, which in turn was resulting in very high imports in February
- Combined with grid constraints caused by the exclusion of Swissgrid infrastructure elements from the Flow Based Market Coupling (FBMC) algorithm this could pose an adequacy risk, especially in a 70% minRAM flow-based scenario with a resulting lower import capacity.

To perform this sensitivity a total of 1700 MW nuclear production in France and 1190 MW nuclear production in Switzerland were removed from the Base Case. Furthermore, the NTCs on the Swiss border were reduced according the following table:



Area	Import CH		Export CH	
	PLEF 2025 [MW]	MAF 2025 [MW]	PLEF 2025 [MW]	MAF 2025 [MW]
AT → CH	800	1200	800	1200
DE → CH	1700	2700	2700	4600
FR → CH	2500	3700	1000	1300
IT → CH	1650	1700	2000	3750

Table 10: NTC for Switzerland in Sensitivity 2: Low Nuclear & Low NTC CH

6. Results of the adequacy assessment

This section shows the results for the base case as well as for the two sensitivities. There are certain differences between this study and the MAF 2019. One of them is the fact the MAF 2019 used five different adequacy tools resulting in the fact that the average results of all five tools being displayed in the MAF report, while the final results shown in the PLEF study are derived by one tool only. Furthermore, the MAF 2019 neither uses a flow-based approach nor applies the adequacy patch for the time horizon 2025.

As the date of freezing the data collection is different for both studies and on top of that, for this study, data was updated until the end of 2019, changes in input data consequently contribute to differences in the results.

Section 6.1 shows a comparative synopsis of this study's results and the ones obtained in the MAF 2019. Section 6.2 summarizes this study's results, detailing the impacts of the two sensitivities carried out.

6.1 Synopsis of results in MAF 2019, target year 2021, and PLEF 3.0, target year 2025

Figure 23 shows the base case results for the MAF 2019 and for this study in an overview. In MAF 2019, only the time horizon 2021 was assessed in flow-based. This study only covers the time horizon 2025, using the flow-based approach.

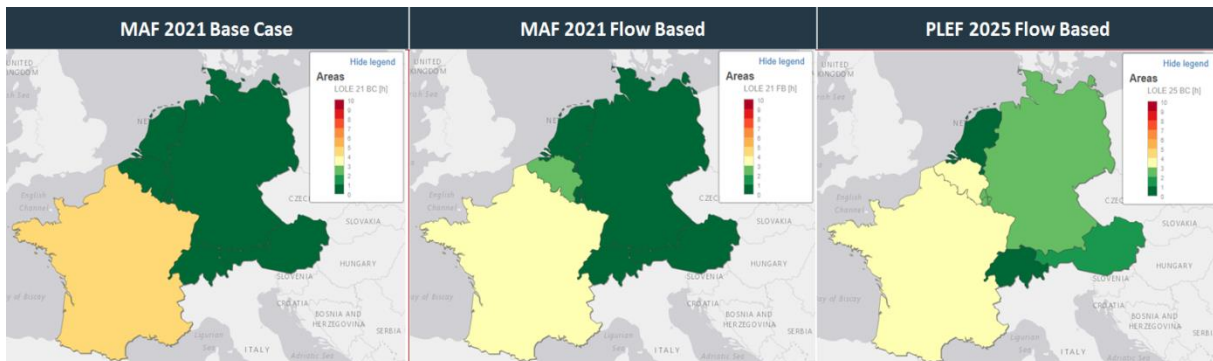

Figure 23: MAF 2019 results for the time horizon 2021. Left: NTC approach. Right: Flow-based approach.

For France, the Netherlands and Switzerland, the LOLE prediction for the time horizon 2025 resulting in this study is more or less equal to the results obtained in the MAF 2019 for the time horizon 2021.

For Austria, Germany and Luxembourg, this study's LOLE estimations for the time horizon 2025 are higher than the ones resulting in the MAF 2019 flow-based approach for the time horizon 2021. For these three countries, this study's increasing LOLE estimations can be attributed to the improved modelling of grid constraints using the flow-based approach.

For Belgium, the relevant results are those considering a flow-based approach, since all the borders with other PLEF countries are within CWE Flow-Based Market Coupling (FBMC). The remaining border is with UK via the 1000 MW HVDC interconnector NEMOLink. MAF 2019 predicts a LOLE =2.9 (~ at the Reliability Standard of LOLE=3) using the flow-based approach for 2021. The LOLE value for Belgium in the PLEF GAA 3.0 is for the base case in 2025 LOLE ~3.3. This value is slightly higher than

the Reliability Standard (RS) but in line with the assumptions considered (see 4.2 for details) which should allow Belgium to respect its RS criteria of LOLE =3. Those assumptions assume a certain volume of ‘new-built capacity’ needed after the nuclear phase-out. The sensitivity ‘Low Gas’ considers the risks associated, should this ‘new-built capacity’ be at risk.

6.2 Results summary PLEF GAA 3.0 for 2025

Table 11 and Figure 24 show the indicators for EENS and LOLE over all the Monte-Carlo years.







PENTA Pentalateral Energy Forum		PLEF 2025 Base Case		PLEF 2025 Low Gas (-7,5GW)		PLEF 2025 Low Nuclear (-2,9GW) / Low NTC CH	
Area	ENS [MWh]	LOLE [h]	ENS [MWh]	LOLE [h]	ENS [MWh]	LOLE [h]	
 AT	819	1,7	2004	3,8	1055	2,3	
 BE	3706	3,3	15290	8,1	5328	4,6	
 CH	98	0,2	1178	1,4	4001	2,9	
 DE	5245	2,1	13405	4,3	6760	2,7	
 FR	9766	3,3	22543	7,1	15847	4,6	
 LU	66	2,1	170	4,3	86	2,7	
 NL	0	0,0	0	0,0	0	0	

Table 11: Average ENS and LOLE for the base case and the two sensitivities

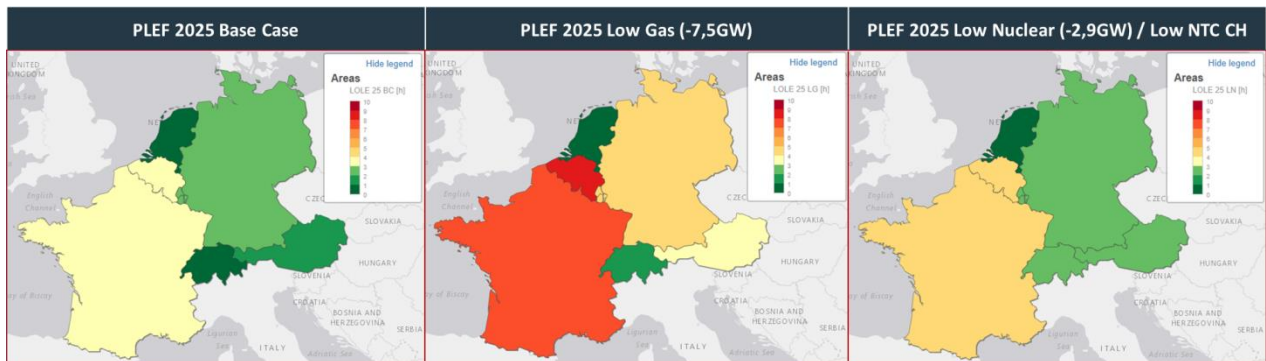

Figure 24: Average LOLE for the base case and the two sensitivities in the geographical context

Base Case 2025

The Netherlands remain without ENS in the base case for 2025 as well as in the two sensitivities. In all other countries in the PLEF region, varying levels of scarcity are visible, albeit on a low level if compared to demand levels: E.g., the observed average ENS in Switzerland for the base case 2025 (98 MWh) represents 0.06% of the Swiss average electricity consumption on a winter day (160 GWh).

Simulations show tighter situations in France, Germany and Belgium (and the loads of Luxemburg directly connected to these two countries). Nevertheless, France and Belgium’s adequacy indicators do not significantly deviate from National Reliability Standards (max. LOLE of 3hrs/year).

While system ENS is larger for the Low Gas sensitivity (55 GWh) than for the Low Nuclear / NTC CH sensitivity (33 GWh), the evolution of individual scarcity from the base case towards the two sensitivities varies from country to country.

Low Gas sensitivity 2025

The Low Gas sensitivity shows the highest impact in Belgium and France, for which the LOLE values found are above their National Reliability Standard (max. LOLE of 3hrs/year). These results are in line with the fact that Belgian and French gas capacities are respectively 2.5 GW and 2.2 GW lower than in the base case. For Austria (1.2 GW less gas capacity), the Netherlands (1.6 GW less gas capacity) and Luxemburg (0.1 GW less gas capacity), the impact is moderate.

Germany and Switzerland encounter considerably higher levels of ENS for the Low Gas sensitivity compared to their base case results, although their installed gas capacity remains unchanged for this sensitivity. The same applies to Luxemburg whose gas capacity is only reduced by 0.1 GW. This underlines the regional aspect of generation adequacy.

Low Nuclear / CH NTC sensitivity 2025

For the Low Nuclear / CH NTC sensitivity, nuclear capacity is 1700 MW lower in France and 1190 MW lower in Switzerland. For all other countries, the installed capacity is unchanged compared to the base case. Additionally, NTCs between Switzerland and the neighbouring zones are reduced in order to take account of increasing unscheduled flows through Switzerland due to the fact that Switzerland may not be included in the flow-based market coupling (FBMC) in 2025 (see section 4.6 for details). Switzerland is the only country that faces its relative highest ENS and LOLE values in this sensitivity. For all other countries, the situation is most tight in the Low Gas sensitivity. However, compared to the base case, the increase in ENS and LOLE is still significant for some other countries, e.g. for France and Belgium where LOLE rises from 3 hours to 4.6 hours for both, above their Reliability Standard.

Since both nuclear capacities *and* NTCs are reduced in this sensitivity, the increasing LOLE in Belgium, France and Switzerland compared to the base case cannot exclusively be attributed to either of the changes. However, this sensitivity still shows that the exclusion of Swiss network constraints from the FBMC algorithm can potentially bear negative effects on the regional adequacy situation in addition to potential re-dispatching needs during real time system operations. After all, this sensitivity clearly emphasizes that generation adequacy can only be monitored and guaranteed on a regional level.

6.3 Sensitivity of Base Case results on Monte Carlo years

Figure 25 below shows the actual distribution of total number of hours with ENS per Monte Carlo year in the Base Case 2025 for AT, BE, DE and FR⁴². The LOLE values reported in Table 11 for the Base Case are obtained from the same data source as Figure 25.

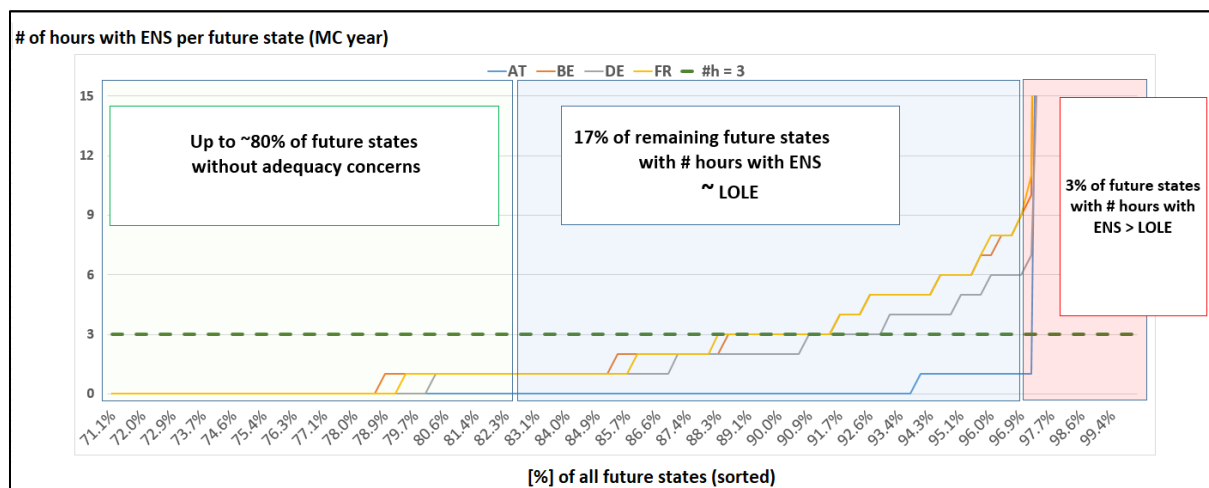

Figure 25 Distribution of # hours with ENS per future state (Monte Carlo years). LOLE refers to average number of hours with ENS

Green box:

Between **0 and 80%** of all future states analysed (i.e. MC years), no adequacy concerns have been identified in any country of the CWE PLEF region. Please note that only the last part of the spectrum of future states from 70% to 80% is shown in the green box for clarity. Between 0% and 80% of the future states the number of shortage hours is equal to **0** for all countries.

Blue box:

For **17%** of the remaining 20% of future states which were analysed, adequacy concerns have been found in countries of the CWE PLEF region. The values of shortage hours encountered range between 1 and 10 hours. The value of LOLE equal to 3 hours is shown for indicative purposes in the figure (green dotted line). These **17%** of future states correspond to the share of future states for which adequacy concerns are of the order of magnitude of the LOLE values up to 10 hours with ENS.

Red box:

Only 3% of all future states (between 97% and 100%) present extreme situations for which the shortage hour values found can be significantly larger than the LOLE values reported in the results table.

Conclusion:

For the **Base Case 2025** (Figure 25) it can be concluded that for **80%** of the future states analysed, no adequacy concerns are expected. Furthermore, adequacy concerns for a numbers of hours between 1h and up to 10h might **occur within 17%** of **all future states analysed**. Finally, **3%** of future states

⁴² The trend is similar for CH and LU. For simplicity reasons this is not shown.

analysed present shortage hours per future states (Monte Carlo year) significantly higher than e.g. the reference value of LOLE=3h chosen in the example.

6.4 Focus on representative critical hours

In the previous chapters, statistical indicators such as LOLE and EENS are provided. These indicators evaluate the global risk for the system and provide an overall picture focussing on the average of the distribution. In addition, some studies show the tail of the distribution to evaluate extreme conditions but without focussing on the hourly simulation. This is based on the assumption, that the majority of situations can be categorized as average conditions and only a few situations can be categorized as extreme conditions. This is shown in Figure 26 below.

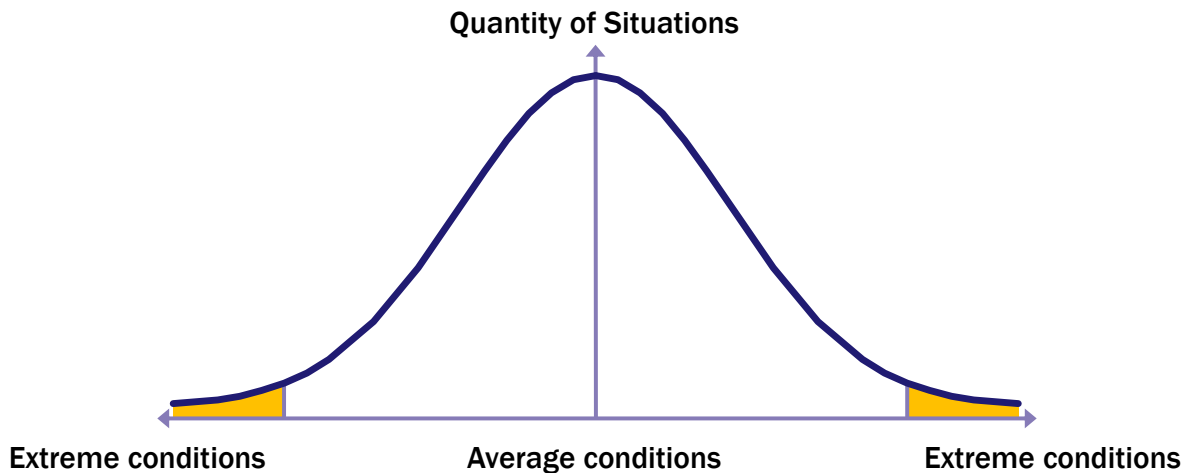

Figure 26: Qualitative distribution of situations with average and extreme conditions.

Relying only on the statistical indicators when evaluating the results, hides the fact that TSOs have to manage and operate the system in every hour of the year.

The aim of this chapter is to focus on hourly resolution and to make an analogy between historic constraining situations and the simulations that have been made for the purpose of the study. The goal of this analysis is not to focus on specific countries, but on the global dynamic of the region. All the data is displayed at regional PLEF level and not country level.

6.4.1 Past constraining situations from system operations perspective

Situations constraining the adequacy of the system are rare but occur at least every few years. For example, in January 2017, the consumption of the PLEF area was high (due to low temperature in Europe) while at the same time the infeed of wind varied a lot from one week to the other.

The historic load and RES values for the PLEF region for a period of three weeks (09.01.2017 - 30.01.2017) from Monday 10.01.2017 to Sunday 30.01.2017 are depicted in Figure 27. With the increasing share of RES, hours with high load and low RES infeed are going to be especially relevant from system adequacy perspective, as revealed in this analysis.

During this period, TSOs did not have to activate extreme measures like load shedding, but additional measures like increasing the cross border capacities in order to further increase the exchange within the region, were necessary to maintain a high level of security of supply.

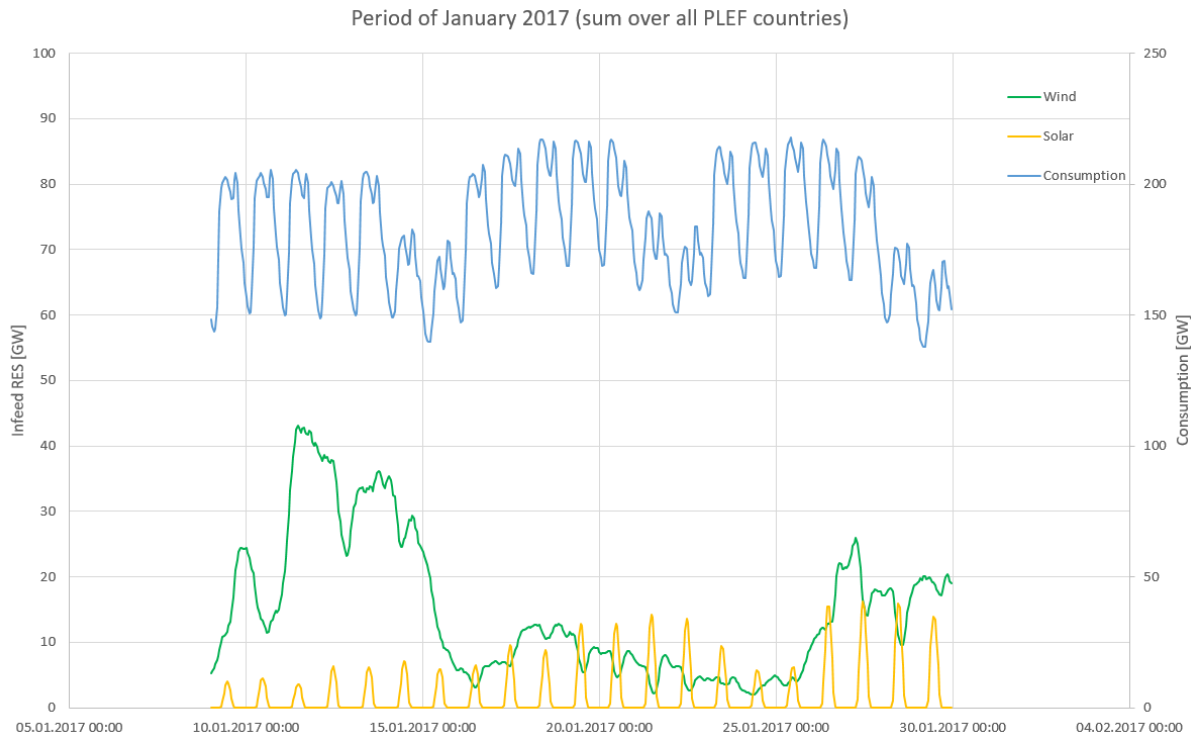

Figure 27: Historic load and RES values for the PLEF region for the time period (09.01.17 - 30.01.17).

6.4.2 Simulations made in the PLEF study for 2025

As already mentioned above, critical situations from generation adequacy perspective occur in the tails of the distribution function Figure 26. Therefore, adequacy problems have a low probability of occurrence but on the other hand, they have a high impact on the interconnected system.

In the following paragraph, we focus on the simulation results for a dedicated week, which is the one of the most constraining ones from adequacy perspective observed in this study. Figure 28 is created in a similar manner as the one for the historic values (Figure 27), which means that the RES infeed and the consumption have been summed up for all PLEF countries; additionally the occurrence of ENS is indicated.

In order to identify this week, the sum of the LOLE and the ENS for all the countries of the PLEF area was computed for all weeks simulated. In the period shown in Figure 28, covering the timeslot of one week (Monday to Sunday), up to 3 countries in the region face a simultaneous scarcity.

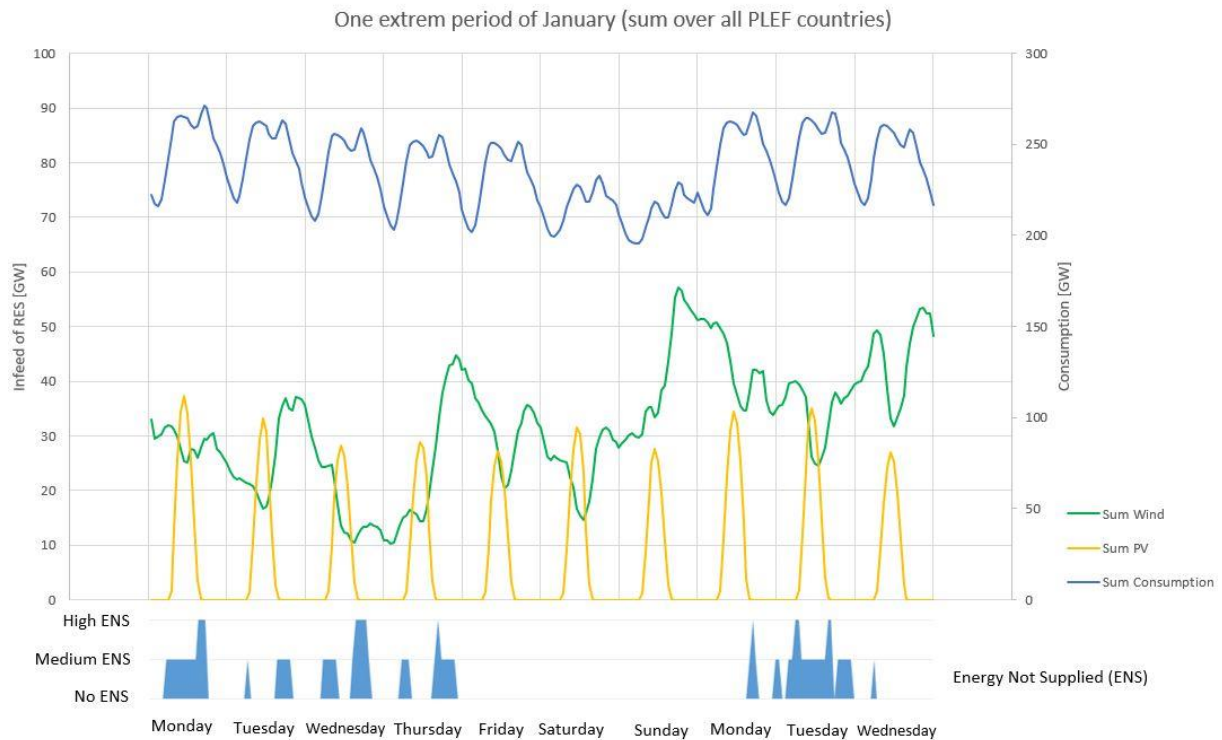

Figure 28: Simulation results for one week with RES infeed and consumption summed up for all PLEF countries. Occurrence of ENS is also indicated.

During this period, the consumption in the PLEF region is very high due to low temperature in central west Europe. Furthermore, the system is stressed due to high needs of import for several counties in the region. The general observation is that the occurrence of ENS happens mainly at the evening peak hours around 19:00. During these hours, the solar infeed is zero and cannot contribute supplying the consumption. As the wind infeed is also on a low level, the region mainly relies on the available hydropower and thermal power plants.

During this period, the ENS is up to 6% of the consumption of the region. In case TSOs would face such a situation in daily system operational business, they would have to take extreme measures to manage these hours. These measures could comprise the activation of emergency contracts, the increase of cross border exchanges or even load curtailment. These operational measures are difficult to model in an adequacy study.

6.4.3 Conclusions on critical hours analyses

Current probabilistic generation adequacy studies mainly focus on average situations using statistical indicators (e.g. LOLE, EENS). From system operations perspective, it is necessary to manage the system at every point in time.

Even if the probability of occurrence of critical situations is low, they can be observed in simulations and also in reality.

Unforeseen events like e.g. additional (unplanned) unavailability of power plants can have an impact on the system, especially during critical situations.

Even with low LOLE or EENS levels in adequacy simulations there might still be situations where system security is under stress (see Figure 25). However, the risk of critical situations that cannot be man-

aged during daily system operation is not reflected in the LOLE or EENS levels of the simulation results.

6.5 Impact of capacity reserves in Germany on the LOLE results for 2025

For Germany an additional ex-post-analysis was conducted in order to evaluate the impact of the Switchable Loads and the Capacity Reserve on the results for 2025. Table 12 below shows the impact on LOLE levels in Germany and Luxembourg after application of the German switchable loads and capacity reserves. In the first row of the table the original LOLE values can be found. The second line shows the impact of 1 GW additional capacities coming from Switchable Loads contracted and operated by the German TSO. This additional capacity already leads to a significant reduction of the resulting LOLE in all three scenarios.

In the third line of the table, 2 GW of additional capacity provided by the Capacity Reserve are taken into consideration. As a result the LOLE of all three scenarios is further reduced for Germany and Luxembourg.

At the point in time of this study, roughly 1GW of capacity reserve was contracted by the German TSO until 2022 since there were not enough offers to cover the full 2 GW reserve capacity demand. It is however envisaged that 2GW of capacity reserve will be contracted by 2025.



	Reserve	PLEF 2025 Base Case	PLEF 2025 Low Gas	PLEF 2025 Low Nuclear / Low NTC CH
	[MW]	LOLE [h]	LOLE [h]	LOLE [h]
Original	0	2,1	4,3	2,7
Switchable loads	1000	1,0	2,5	1,4
Switchable loads + Capacity Reserve	3000	0,6	1,6	0,7

Table 12: Impact of capacity reserves in Germany on the LOLE results in Germany and Luxembourg

Note that the final results provided in the Executive Summary include the results shown in Table 11 for all PLEF countries, except for Germany and Luxembourg, for which the final results are the ones provided in Table 12 (including switchable loads and Capacity Reserve of 3000 MW) above.

6.6 Disclaimers and TSO Comments on results

6.6.1 Austria

Input Parameters

The input parameters used in the study reflect the state of knowledge at that time.

In the specific case of Austria, the respective technology-specific planned expansion paths were changed by the current government programme and therefore differ at the time of publication.

Flow Based Approach

The current applied flow-based methodology developed by ELIA, reflects CWE countries only, while all other bidding zones in Europe are connected via NTC borders. In this context, the post-processing Adequacy Patch, which impose the curtailment sharing rule as applied in the Euphemia algorithm for day-ahead market coupling, is only active on flow-based countries within the CWE region; thus, only one border of Austria, namely AT – DE, is reflected. Since Austria is located very centrally in Europe, with commercial exchanges available on six borders, a proper treatment of all borders shall be ensured. Nevertheless, the approach used in the PLEF 2020 study is a solid and innovative starting point, from which Austria expects a continuous evolution, including a comprehensive representation of its flow based and NTC borders in the Adequacy Patch and curtailment sharing rule.

Low probability results

Careful consideration should be taken concerning the average results published in the PLEF 2020 study, showing non-negligible LOLE and ENS values for most of the PLEF countries. It has to be clearly stated that such values result from a few very severe cases, which have a high impact on the average results. These “high impact, low probability” events reflect seldom combinations of critical climate conditions, RES infeed and forced outages of thermal power plants and grid interconnectors. It is therefore recommended to give a closer look to the P95% (1 out of 20 events) values, which highlight that a greater majority of the forecasted future scenarios show a more secure generation adequacy.

6.6.2 Belgium

Comments on 2021 results

For 2021, nuclear assumptions include an assumed unavailability of one third of the nuclear fleet, which is a result of an analysis of the observed nuclear availability in recent winters. For a country such as Belgium, which nowadays relies on a large share of nuclear capacity, it is key to include a realistic unavailability based on past experience with long-duration outages of those plants due to specific overhauls. This highlights the impact these events have on the country’s adequacy. This assumption is also in line with the ‘high impact – low probability’ storyline used in the SR study 2019 (see footnote ₁) and the Elia study 2019 (see footnote ₃).

For the Base Case in 2021, the MAF2019 NTC results show an average LOLE close to 1 hour, lower than the current adequacy criteria for Belgium of $LOLE \leq 3$. Furthermore, a Flow-Based sensitivity was performed in MAF 2019 for 2021. The method applied is in line with the implementation approach applied in the latest PLEF2017 study, and included the mandatory 20% minimum Remaining Available Margin (MinRAM20%) within CWE. The results for Belgium after this sensitivity provided values of LOLE around the adequacy criteria $LOLE \sim 3$ h. The FB approach provides a more accurate representation than the NTC approach of what is observed daily within the CWE region.

Comments on 2025 results

The PLEF Ministries requested as main methodological requirement of the PLEF 2019 study to perform a FB 70%CEP analysis for 2025. The Flow Based model developed for the Elia study 2019 (see footnote ₃) study by Elia was therefore proposed by PLEF TSOs as model for the PLEF 2019 study. The model was considered as best available Flow Based model incorporating the expected evolution of the grid from today’s state until 2025 as well as considering the impact of the 70%CEP rule for 2025 within the PLEF region. Furthermore, the Adequacy Patch is applied to the simulation, which imposes

the curtailment sharing rule as applied in the Euphemia algorithm for day-ahead market coupling. The implementation of the Adequacy Patch in the PLEF report considers the flow-based countries within the CWE region.

A volume of 2.5GW new built capacity is considered for 2025 (on top of assumed developments in DSR, storage and RES). This 2.5 GW capacity was identified in the Elia study 2019 (see footnote 3) study as new built capacity needed to meet the reliability criteria in the 'CENTRAL/EU-BASE' scenario for 2025 (which corresponds to the MAF and PLEF 'Base Case' scenarios).

The main added value of the PLEF report is the assessment of relevant regional 'stress test' sensitivities defined jointly by PLEF Ministries, NRAs and TSOs for the region.

An important sensitivity is the 'Low Gas' sensitivity. This sensitivity confirms an important structural adequacy deficit in 2025 for Belgium (LOLE ~ 8.1h), once the nuclear phase-out is completed and in case that the 2.5GW new capacity above mentioned would be at risk due to adverse economic conditions. There is no guarantee that investment in the identified new capacity would occur in the future in Belgium without a market wide CRM mechanism. Such risks are captured within the storyline agreed between PLEF Ministries for this 'Low Gas' sensitivity. Furthermore, the structural adequacy deficit identified is also related to risks beyond Belgium's control, as the sensitivity storyline also reflects the effect that unavailability of generation or interconnection capacity in other countries within the PLEF region, besides Belgium, has on Belgium's adequacy. Finally, the value of 2.5GW for Belgium provides a lower bound on the capacity at risk. Should so-called 'existing capacity needed refurbishment' of 1.6GW be also deemed *at risk* in Belgium, the amount of capacity that would rely on a market wide CRM to ensure adequacy of Belgium would be around 3.9GW - 4.1GW.

6.6.3 Germany

With a LOLE of roughly two hours in the Base Case, Germany's dependency on imports will increase in the future.

The results of both sensitivities show higher LOLE values than for the Base Case, whilst the assumed capacities for Germany are the same as in the Base Case. The reason for this higher LOLE level is that the adequacy level of Germany depends directly on the assumptions taken for all the European countries, where significant gas capacities have been withdrawn. This highlights the increased interdependence of the European electricity system with regard to system adequacy.

In order to evaluate the contribution of additional capacities to the adequacy level in Germany, an ex-post analysis has been conducted. Additional capacities provided by the Load Curtailments and the Capacity Reserve are reducing the LOLE which leads to an improved adequacy level. In this study these reserves are assumed to be for domestic German use only and do not increase the adequacy levels of other countries.

6.6.4 France

RTE produces every year an annual risk assessment through its national adequacy report⁴³ on a time horizon of five years. The results of the last MAF and this PLEF GAA 3.0 seem to be globally in line

⁴³ <https://www.rte-france.com/fr/article/bilan-previsionnel>

with national elements even if the LOLE is slightly higher in the MAF and in the PLEF GAA. For both time horizons 2021 and 2025, the MAF and the PLEF GAA highlight average loss of load expectations about 1 hour more than in the last French national adequacy study.

The discrepancy between both analyses mainly results from the fact that they do not use the same climate database. While the one used in the French study models 200 potential forecasting climatic years with a full correlation between load, solar and wind conditions, the one used for the different studies at ENTSO-E (Seasonal Outlook, MAF, TYNDP) and in the PLEF GAA is based on 35 historical climatic years. Among these 35 scenarios, the cold wave of 1985 would be the most critical event regarding adequacy issues in France in the electric system of today and thus cover an important part of the adequacy risks identified in this study. For this specific simulated climatic year, the peak load reaches 117 GW. By comparison, the demand record in France occurred in February 2012 with a value of 102 GW. The effect of such situations of very high peak load in winter is distributed more smoothly within the database of 200 forecasting climate scenarios used by RTE. Evolution towards a similar database for future ERAA studies is under discussion at ENTSO-E, with the contribution of RTE.

The nuclear availability in France is also taken into account differently in both resource adequacy assessments. The availability patterns for nuclear plants are determined through a fully probabilistic process in the PLEF GAA, whereas the French generation adequacy study combines a deterministic approach for the ten-year inspections (information shared via the official transparency channels - REMIT) and a probabilistic one for the other outages. Hence the impact of this methodological discrepancy depends on the target year, since the declared unavailability planning is not constant throughout the next years.

Also, the flow-based approach, which is studied only through sensitivity in the MAF, is modelled for the central scenario in the French national study.

Lastly, the data collection for the French generating fleet does not occur in the same time, leading to potential discrepancies based on the latest information.

As a consequence the results of the MAF and the PLEF GAA adequacy studies for France have to be treated cautiously and read jointly with the French national adequacy study, which is published every year (also called "Bilan prévisionnel").

6.6.5 Luxembourg

Input data

The input data for demand and generation used in the study reflects the latest available information end of January 2019. The parameters used are based on the draft NECP published February 2019.

Simulation results

As described in chapter 3.8.4 the modelling of Luxembourg and the interconnections to the neighbouring countries is rather specific. A similar modelling approached for Luxembourg was used in the PLEF study as in MAF 2019 study. The LOLE and ENS values are calculated for the 3 different nodes namely LUG, LUF, and LUB. Nevertheless, only the values for the public grid operated by the Creos

Luxembourg represented by the market node LUg are relevant and published in the report as LU or LUg results.

6.6.6 Switzerland

The results for 2025 are generally consistent with the findings of the national System Adequacy study 2019 of the Swiss Federal Office of Energy (SFOE).

With regard to Sensitivity 2 Low nuclear / Low NTC Switzerland, we would like to point out once again that cross-border trade is of utmost importance for Switzerland. In the worst case scenario, the NTC on Switzerland's northern border could be even lower with the implementation of the 70% minRam in 2025 without the participation of Swissgrid in the FBMC. Therefore, the integration of Swissgrid's infrastructure elements has to be properly considered in the capacity calculation methodologies of Switzerland's neighbourhood countries in order to guarantee the grid security of the continental European grid. Consequently, correct mechanisms should be designed in order to consider this issue, as long as Switzerland is not yet part of the FBMC.

7 Conclusions and Lessons learnt

Results

For the base case LOLE values do not exceed the reliability standards set by some of the PLEF countries (see Table 2). Both in the base case and the sensitivities analysed, for all countries of the PLEF Region, except for the Netherlands, LOLE is above zero. The two sensitivity analyses show that adequacy risk can occur, since LOLE values exceed the reliability standards set by some of the PLEF countries.

Methodology

The definition of the sensitivities was performed in collaboration between Ministries, Regulators and TSOs in the PLEF group and has turned out to be a major added value for this 3rd Regional adequacy assessment. These sensitivities provide so-called 'stress test' situations for the region, to e.g. test its resilience.

For first time, the PLEF study applied a Flow-Based approach for midterm horizon, taking into account the 70% minRAM as required by the Clean Energy Package (CEP).

The analysis of critical hours shows that despite their low probability of occurrence, critical situations are observed both in the PLEF simulations as well as in real system operation over the last years. In turn this means, even with low LOLE and EENS levels in adequacy simulations, the electrical system might face particular situations where system security is under stress. Additional unforeseen events in such situations can put the daily system operation even more under pressure which might lead to the activation of exceptional measures. The full scope of operational risks in such particularly critical situations are not reflected in the statistical adequacy indicators of the PLEF simulation results.

Outlook beyond 2025

This study considers the year 2025 as main time horizon. Hence, there is still a significant amount of coal and lignite capacity in the PLEF area by 2025 (more than 25 GW) in this study. Additional coal capacity might be decommissioned from 2025 onwards, when countries will be preparing to reach the 2030 EC Green Deal targets. This is not addressed in this PLEF study, but might have to be considered in future TSO studies.

Lessons learnt

Flow-Based modelling for the midterm horizon considering all implemented grid investments for the considered time horizon (2025) and including the 70% minRAM requirements from CEP is a complex and time consuming task. PLEF TSO significantly profited from methodological evolutions within national studies by TSOs in order to be able to implement a useful model to meet the expectations in this 3rd PLEF study. This work adds value also on the European level, for instance by demonstrating the effects of flow-based market coupling and the adequacy patch on the adequacy results.

Further work on several important aspects of adequacy studies is already planned and will occur within ENTSO-E in the framework of the ERAA (Electricity Market Regulation 2019/943). For example, the current knowledge base regarding demand response potential in the individual countries turned out to be heterogeneous. This indicates the need for a common attempt to improve the availability and quality of data on DSR not only in the Penta-region, but also in whole Europe.

Additionally, further work seems needed to better integrate interactions between market price signals and the economic assessment of power plant operators regarding the profitability of assets in modelling within the adequacy assessment, also in relation to the legal requirements of the Electricity Market Regulation 2019/943.

TSOs expertise in the framework of ENTSO-E would be required for this work. Furthermore TSO expertise will be as well required within legally mandated national studies by national regulation.

These methodological improvements are challenging (further extension of the Flow-Based methodology, implementation of Economic Viability checks, evolution of the PECD, etc..) and will have to be addressed mostly in the framework of the development of the ERAA models within ENTSO-E.

In this respect, the evolution of the scope of the PLEF Generation Adequacy study regarding methodological improvements should be carefully discussed.

8 Appendix

8.1 FB modelling details

The flow-based method implemented in day-ahead market coupling uses Power Transfer Distribution Factors (PTDF) factors that make it possible to model the real flows on the lines based on commercial exchanges between countries. PTDF⁴⁴ division factors allow to estimate the real flow that are to be expected in the different grid lines as a function of the commercial exchanges to be settle in the market between countries. Typically energy flows are unevenly distributed over the different paths between the different areas considered when there is a commercial exchange, e.g. of 100 MW considered between two given areas A and C, as shown below:

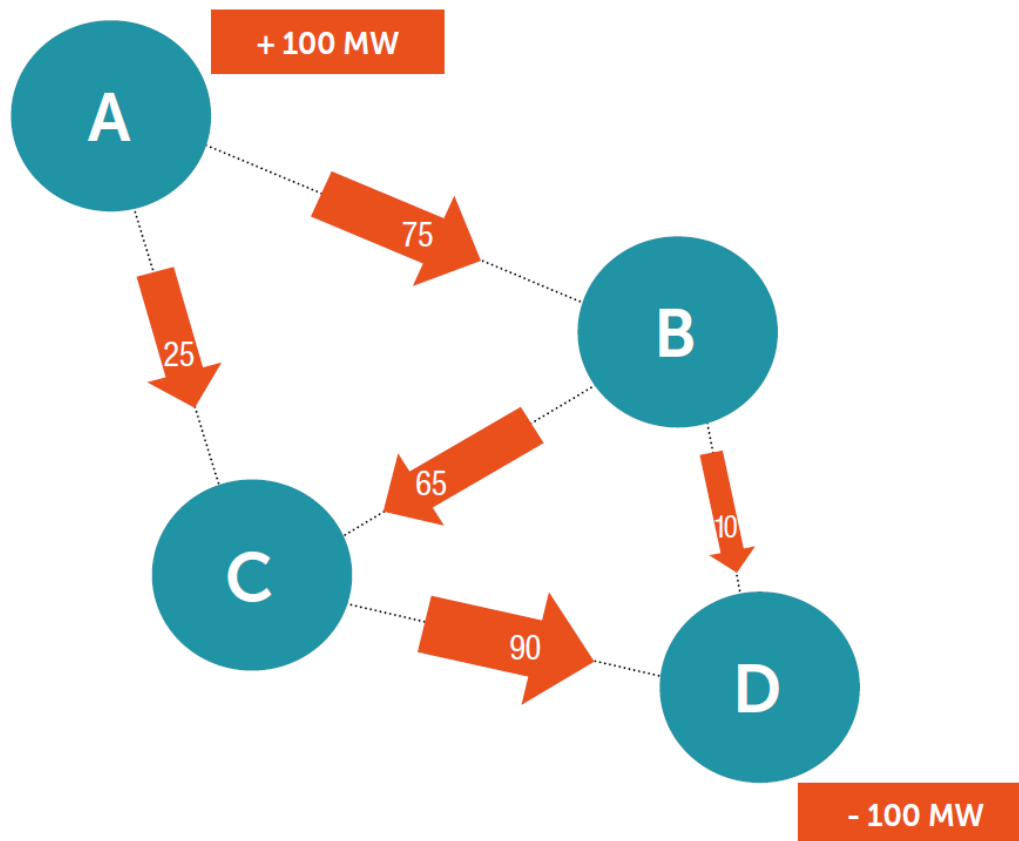

Figure 29: Systematic example for the difference between market flow and the real physical flows taken into consideration when using FB modelling

EXAMPLE: Commercial exchanges between two countries can generate physical flows through other borders. Electricity flows via the path with the least impedance (resulting physical flows from an energy exchange of 100 MW between 2 zones).

The PTDF factors of this example determine that:

- 75% of the injection from A goes to B and 25% of the injection from A goes to C
- 65% of the injection from B goes to C and 10% of the injection from B goes to D
- Finally the total injection coming into C is 25% + 65% = 90% which goes to D

⁴⁴ PTDF: Power Transfer Distribution Factor

Since the commercial exchange of 100 MW is a between A and D in the case above, i.e. exchange (A → D), the PTDFs for each grid element is referred as PTDF(A → D). In the example above

Commercial Exchange (A → D)	Grid Element 1	Grid Element 2	Grid Element 3	Grid Element 4	Grid Element 5
PTDF _(A→D)	25%	75%	65%	90%	10%

A matrix of exchanges vs grid elements can therefore be defined (only A → D numbers shown for simplicity here)

PTDF	Grid Element 1	Grid Element 2	Grid Element 3	Grid Element 4	Grid Element 5
PTDF _(A → B)	-	-	-	-	-
PTDF _(A → C)	-	-	-	-	-
PTDF _(A → D)	25%	75%	65%	90%	10%
PTDF _(B → C)	-	-	-	-	-
PTDF _(B → D)	-	-	-	-	-
PTDF _(C → D)	-	-	-	-	-

For each hour of the year, the impact of energy exchanges on each line/element (also called ‘Critical Network Element (CNE)’) are calculated taking into account the N-1 criteria (Contingencies), hence these are referred as CNEC+Cs or CNECs. A CNEC is a physical element of the grid, which has reached its maximum transmission capacity and therefore constrains the total flow of the system around it.

In typical situations, energy exchanges lead to many constraints. Those constraints form a domain of possible maximum energy exchanges between the FB countries (this is called the flow-based domain).

Looking at the system above the basic equations defining the condition of each of the network elements in the system considered as CNECs is given by the following type of equation:

$$\begin{aligned}
 &PTDF(A \rightarrow B) * Exchange(A \rightarrow B) + PTDF(A \rightarrow C) * Exchange(A \rightarrow C) + \\
 &PTDF(A \rightarrow D) * Exchange(A \rightarrow D) + PTDF(B \rightarrow C) * Exchange(B \rightarrow C) + \\
 &PTDF(B \rightarrow D) * Exchange(B \rightarrow D) + PTDF(C \rightarrow D) * Exchange(C \rightarrow D) \leq RAM
 \end{aligned}$$

, where PTDF and RAM (Remaining Available Margin) need to be calculated for each CNEC.

Each such linear constraint can be drawn on the plane defined by the relevant exchanges between any two areas of the system considered (in this case the plane of Exchange (A → B) vs Exchange (A → C) as a line (each of the dotted lines in the Figure 30 below).

The set of all intersecting, ‘constraining’ elements, i.e. all relevant CNECs define a polygon (connected grey lines) or so-called FB domain, as depicted schematically below.

In the Figure 30, the coloured squares are plotted for illustration and represent possible so-called Available Transfer Capacity (ATC) domains, which provide the Available Transfer Capacity considering long-term nominated power flows and NTCs in a traditional NTC non-Flow-based scheme.

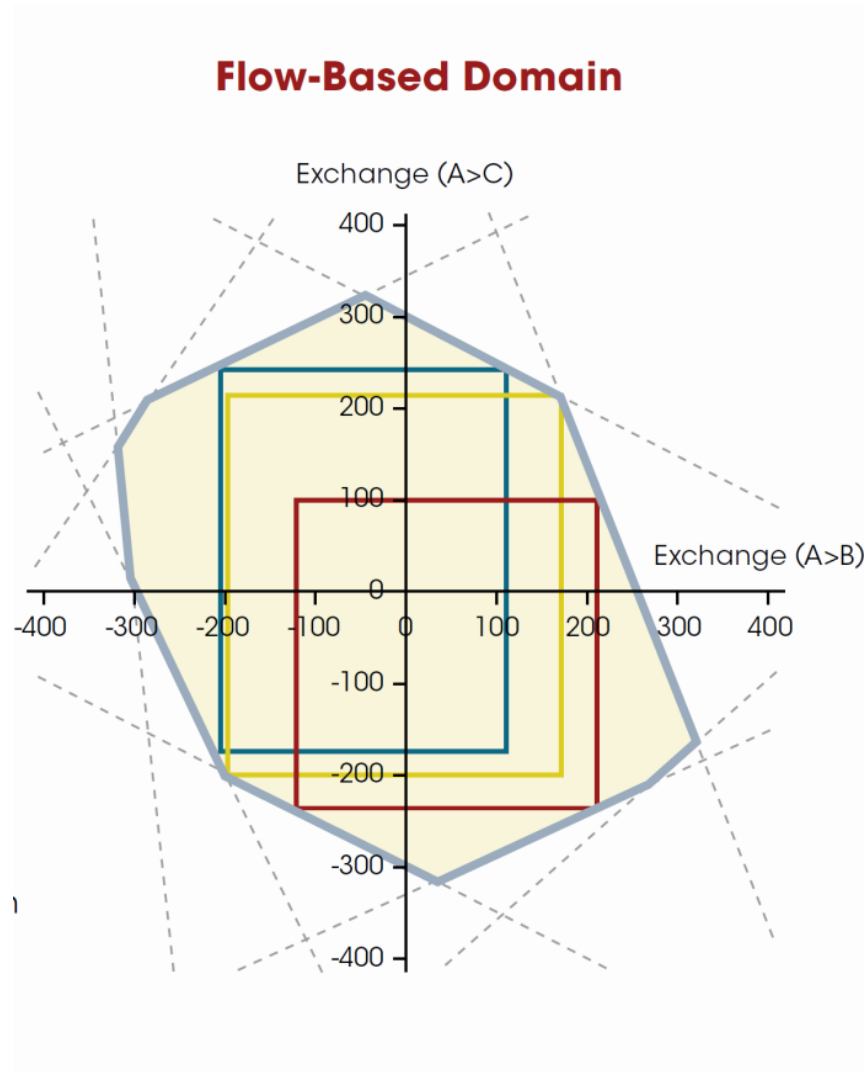

Figure 30: Example of flow-based domain (see CWE Flow-Based⁴⁵)

Thus Flow-based domains are typically constructed based on ‘Critical Network Elements and Contingencies’ (CNECs), taking account: 1) the impact of an outage on these CNECs, 2) a flow reliability margin (FRM) on each CNECs and 3) possibly ‘remedial actions’ that can be taken after an outage to unload part of the concerned network element.

8.2 Adequacy Patch details

Within the EUPHEMIA algorithm⁴⁶ (PCR Market Coupling Algorithm), a mitigation measure has been implemented (see ‘6.8.1. Curtailment minimization’ and ‘6.8.2. Curtailment sharing’ within footnote 46) to prevent price-taking orders (orders submitted at the price bounds set in the market coupling framework) to be curtailed because of “flow factor competition”. The solution implemented in EUPHEMIA within Flow-based market coupling (FBMC) follows the curtailment sharing principles that

⁴⁵ <http://www.elia.be/nl/producten-en-diensten/cross-border-mechanismen/transmissiecapaciteit-op-de-grenzen/flow-based-marktkoppeling-centr-w-europa>

⁴⁶ http://www.nemo-committee.eu/assets/files/190410_Euphemia%20Public%20Description%20version%20NEMO%20Committee.pdf

already existed under ATC/NTC. The objective is to equalize the ratio of curtailment between bidding zones as much as possible.

The implementation of the 'Curtailment minimization' and 'Curtailment sharing' principles within the EUPHEMIA algorithm was approved by the CWE NRAs in 2015. The official documentation of the CWE FBMC solution «CWE FBMC approval package » published on JAO website, was officially updated in November 2015.⁴⁷

Flow factor competition

If two possible market transactions generate the same welfare, the one having the lowest impact on the scarce transmission capacity will be selected first within FBMC. This also means that, in order to optimize the use of the grid and to maximize the market welfare, some buy (demand) bids with higher prices than other buy (demand) bids located in other bidding zones, might not be selected within the flow-based allocation. This is a well-known and intrinsic property of flow-based referred to as "flow factor competition".

Under normal FBMC circumstances, "flow factor competition" is accepted as it leads to maximal overall welfare. However for the special case where the situation is exceptionally stressed e.g. due to scarcity in one or several bidding zones, "flow factor competition" could lead to a situation where order curtailment takes place non-intuitively / non-fairly. This could mean e.g. that some buyers (order in the market) which are ready to pay any price to import energy would be rejected while lower buy bids in other bidding areas are selected instead, due to "flow factor competition". These 'pay-any-price' orders are also referred to as 'Price Taking Orders', which are valued at the market price cap in the market coupling.

Two situations tend to occur prior to the consideration of the "adequacy patch" then:

- ENS can be created for net exporting countries in order to find the lowest ENS for the FB area as a whole.
- Countries with low 'flow-factors' are penalized with ENS to the benefit of countries with high 'flow factors', even if all these countries are at the same time at the maximum market price cap.

These are the situations that the adequacy patch seeks to mitigate by correcting "flow factor competition".

Adequacy Patch principles

The first rule of the patch is that if only one country is in ENS / scarcity, imports will be maximally allocated to that country.

Moreover, the so called 'Local Matching Constraint' is imposed, meaning that "net-exporting" countries shall export only the share of available generation exceeding its local demand and hence they should not have ENS after the final market allocation.

⁴⁷ <https://www.jao.eu/main>

Furthermore, if more than one country is in scarcity, the adequacy patch aims to ‘fairly’ distribute the curtailments across the involved markets by equalizing the ratio “ $x = \text{curtailed price-taking orders} / \text{total volume of price-taking orders}$ ” between the curtailed zones.

The curtailment sharing is implemented by solving a sub-optimization problem, where all network constraints are enforced, but only the acceptance of the price taking volume is considered in the objective function (see footnote 46 for details). The curtailment ratios weighted by the volumes of price taking orders are therefore minimized and as much as possible equalized.

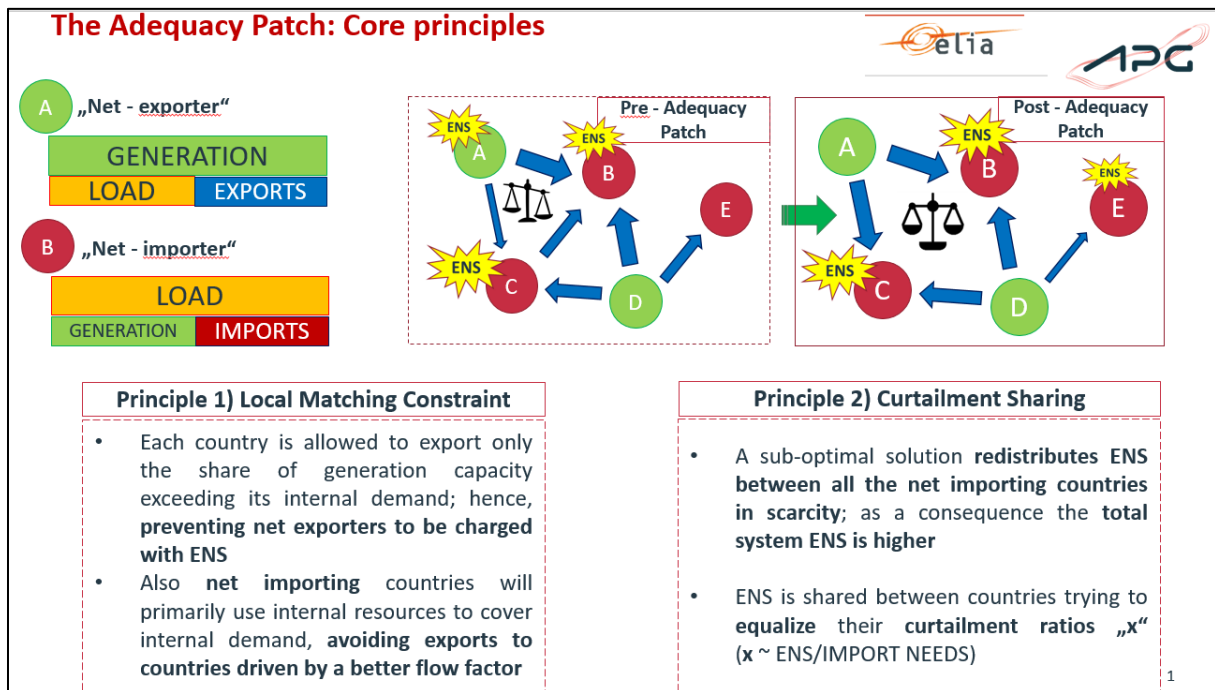

Figure 31 Adequacy Patch principles

The results prior the application of the adequacy patch showed that countries can have ENS while exporting. This is a situation which is not accepted by the EUPHEMIA market coupling algorithm.

After consideration of the adequacy patch, these situations were corrected. For countries with exports during scarcity, no ENS will be found any more. On the other hand, as explained in the figure above, a redistribution of ENS and LOLE between all ‘net importing’ countries in scarcity takes place after application of the adequacy patch.

8.3 Glossary

CACM	Capacity Allocation and Congestion Management
CCGT	Combined Cycle Gas Turbine
CEP	Clean Energy Package
CHP	Combined Heat and Power
CM	Capacity Market
CRM	Capacity Remuneration Mechanisms
CWE	Central West Europe (including AT, BE, DE, FR, LU and NL)
DCM	Decentralized capacity market
DSR	Demand Side Response
EENS	Expected Energy not Served
ENS	Energy not Served
EOM	Energy-only-market
FBMC	Flow-Based Market Coupling
GAA	Generation Adequacy Assessment
GR	Grid Reserve
IEA	International Energy Agency
HVDC	High-Voltage Direct Current
LOLE	Loss of Load Expectation
MAF	Mid-term Adequacy Forecast (ENTSO-E annual report)
MC	Monte Carlo
MILP	Mixed-Integer Linear-Programming
minRAM	Minimum Remaining Availability Margin (to commercial exchange capabilities)
NECP	National Energy and Climate Plan
NRA	National Regulatory Authority
NTC	Net Transfer Capacity
OCGT	Open Cycle Gas Turbine
PECD	Pan-European Climate Database
PEMMDB	Pan-European Market Modelling Database
PLEF	Pentalateral Energy Forum (including AT, BE, CH, DE, FR, LU, NL)
PST	Phase-Shifting Transformer
PTDF	Power Transfer Distribution Factors
PV	Photo Voltaic
RAM	Remaining Availability Capacity
RoR	Run of River
ROW	Rest of the World
SoS	Security of Supply
SR	Strategic Reserve
TSO	Transmission System Operator
TYNDP	Ten Year Network Development Plan
WEO	World Energy Outlook

8.4 Contacts

Name	Surname	TSO	E-Mail
Simon	Art	SWISSGRID	simon.art@swissgrid.ch
Sebastian	Böhm	SWISSGRID	sebastian.boehm@swissgrid.ch
Rafael	Feito-Kiczak	ELIA	Rafael.FeitoKiczak@elia.be
Daniel	Huertas Hernando	ELIA	Daniel.HuertasHernando@elia.be
Gregorio	Iotti	APG	Gregorio.iotti@apg.at
Eppie	Pelgrum	TENNET-NL	eppie.pelgrum@tennet.eu
Julien	Peret	RTE	julien.peret@rte-france.com
Marlene	Petz	APG	marlene.petz@apg.at
Louis	Philippe	CREOS	louis.philippe@creos.net
Vincent	Protard	AMPRION	vincent.protard@amprion.net
Daniel	Rauhut	AMPRION	daniel.rauhut@amprion.net
Peter	Scheerer	TransnetBW	p.scheerer@transnetbw.de
Maïke	Stark	AMPRION	maïke.stark@amprion.net
Berno	Veldkamp	TENNET-NL	berno.veldkamp@tennet.eu